

General Description

MY80N06P used N-channel Enhanced VDMOSFET, is obtained by the self-aligned planar Technology which reduce the conduction loss, improve switching performance and enhance the avalanche energy. The transistor can be used in various power switching circuit for system miniaturization and higher efficiency.



Features

V_{DSS}	60	V
I_D	80	A
$R_{DS(ON)}(at V_{GS}=10V)$	6.5	$m\Omega$
$R_{DS(ON)}(at V_{GS}=4.5V)$	10	$m\Omega$

Application

- Battery protection
- Load switch
- Uninterruptible power supply

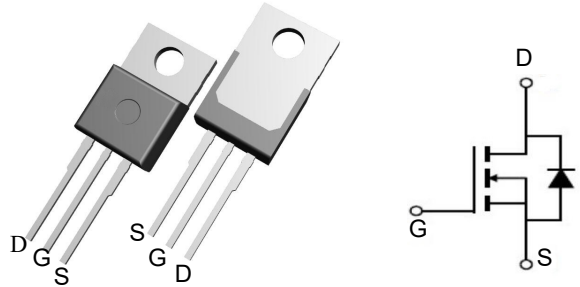

Package Marking and Ordering Information

Product ID	Pack	Marking	Qty(PCS)
MY80N06P	TO-220	80N06P	1000

Absolute Maximum Ratings ($T_C=25^\circ\text{C}$ unless otherwise noted)

Parameter	Symbol	Maximum	Units	
Drain-Source Voltage	V_{DS}	60	V	
Gate-Source Voltage	V_{GS}	± 20	V	
Continuous Drain Current ^c	$T_C=25^\circ\text{C}$	80	A	
	$T_C=100^\circ\text{C}$	60		
Pulsed Drain Current ^c	I_{DM}	184		
Continuous Drain Current	$T_A=25^\circ\text{C}$	14	A	
	$T_A=70^\circ\text{C}$	11		
Avalanche Current ^c	I_{AS}	60	A	
Avalanche energy $L=0.1\text{mH}$ ^c	E_{AS}	180	mJ	
V_{DS} Spike	$10\mu\text{s}$	V_{SPIKE}	72	V
Power Dissipation ^b	$T_C=25^\circ\text{C}$	150	W	
	$T_C=100^\circ\text{C}$	75		
Power Dissipation ^a	$T_A=25^\circ\text{C}$	2.5	W	
	$T_A=70^\circ\text{C}$	1.6		
Junction and Storage Temperature Range	T_J, T_{STG}	-55 to 175	$^\circ\text{C}$	

Thermal Characteristics

Parameter	Symbol	Typ	Max	Units
Maximum Junction-to-Ambient ^A	$R_{\theta JA}$	16	20	$^\circ\text{C/W}$
Maximum Junction-to-Ambient ^{A D}		Steady-State	41	50
Maximum Junction-to-Case	$R_{\theta JC}$	0.8	1.0	$^\circ\text{C/W}$

Electrical Characteristics at $T_J=25^\circ\text{C}$ unless otherwise specified

Symbol	Parameter	Conditions	Min	Typ	Max	Units
STATIC PARAMETERS						
BV_{DSS}	Drain-Source Breakdown Voltage	$I_D=250\mu\text{A}$, $V_{GS}=0\text{V}$	60			V
I_{DSS}	Zero Gate Voltage Drain Current	$V_{DS}=60\text{V}$, $V_{GS}=0\text{V}$			1	μA
					$T_J=55^\circ\text{C}$	
I_{GSS}	Gate-Body leakage current	$V_{DS}=0\text{V}$, $V_{GS}=\pm 20\text{V}$			± 100	nA
$V_{GS(th)}$	Gate Threshold Voltage	$V_{DS}=V_{GS}$, $I_D=250\mu\text{A}$	1.7	2.5	3.2	V
$R_{DS(on)}$	Static Drain-Source On-Resistance	$V_{GS}=10\text{V}$, $I_D=12\text{A}$	$T_J=125^\circ\text{C}$	6.5	8.5	m Ω
				10	12	
g_{FS}	Forward Transconductance	$V_{DS}=5\text{V}$, $I_D=20\text{A}$		75		S
V_{SD}	Diode Forward Voltage	$I_S=1\text{A}$, $V_{GS}=0\text{V}$		0.7	1	V
I_S	Maximum Body-Diode Continuous Current ^G				46	A
DYNAMIC PARAMETERS						
C_{iss}	Input Capacitance	$V_{GS}=0\text{V}$, $V_{DS}=30\text{V}$, $f=1\text{MHz}$		4050		pF
C_{oss}	Output Capacitance			345		pF
C_{rss}	Reverse Transfer Capacitance			16.8		pF
R_g	Gate resistance	$f=1\text{MHz}$	0.3	0.65	1.0	Ω
SWITCHING PARAMETERS						
$Q_{g(10V)}$	Total Gate Charge	$V_{GS}=10\text{V}$, $V_{DS}=30\text{V}$, $I_D=20\text{A}$		53	75	nC
$Q_{g(4.5V)}$	Total Gate Charge			22	31	nC
Q_{gs}	Gate Source Charge			17		nC
Q_{gd}	Gate Drain Charge			5		nC
$t_{D(on)}$	Turn-On DelayTime	$V_{GS}=10\text{V}$, $V_{DS}=30\text{V}$, $R_L=1.5\Omega$, $R_{GEN}=3\Omega$		18		ns
t_r	Turn-On Rise Time			20		ns
$t_{D(off)}$	Turn-Off DelayTime			33		ns
t_f	Turn-Off Fall Time			4		ns
t_{rr}	Body Diode Reverse Recovery Time		$I_F=20\text{A}$, $dI/dt=500\text{A}/\mu\text{s}$		26	
Q_{rr}	Body Diode Reverse Recovery Charge	$I_F=20\text{A}$, $dI/dt=500\text{A}/\mu\text{s}$		125		nC

A. The value of $R_{\theta JA}$ is measured with the device mounted on 1in² FR-4 board with 2oz. Copper, in a still air environment with $T_A=25^\circ\text{C}$. The Power dissipation P_{DSM} is based on $R_{\theta JA}$ and the maximum allowed junction temperature of 150. $^\circ\text{C}$. The value in any given application depends on the user's specific board design, and the maximum temperature of 175. $^\circ\text{C}$ may be used if the PCB allows it.

B. The power dissipation P_D is based on $T_{J(MAX)}=175^\circ\text{C}$. $^\circ\text{C}$, using junction-to-case thermal resistance, and is more useful in setting the upper dissipation limit for cases where additional heatsinking is used.

C. Single pulse width limited by junction temperature $T_{J(MAX)}=175^\circ\text{C}$. $^\circ\text{C}$.

D. The $R_{\theta JA}$ is the sum of the thermal impedance from junction to case $R_{\theta JC}$ and case to ambient.

E. The static characteristics in Figures 1 to 6 are obtained using $<300\mu\text{s}$ pulses, duty cycle 0.5% max.

F. These curves are based on the junction-to-case thermal impedance which is measured with the device mounted to a large heatsink, assuming a maximum junction temperature of $T_{J(MAX)}=175^\circ\text{C}$. $^\circ\text{C}$. The SOA curve provides a single pulse rating.

G. The maximum current rating is package limited.

H. These tests are performed with the device mounted on 1 in² FR-4 board with 2oz. Copper, in a still air environment with $T_A=25^\circ\text{C}$. $^\circ\text{C}$.

Typical Characteristics

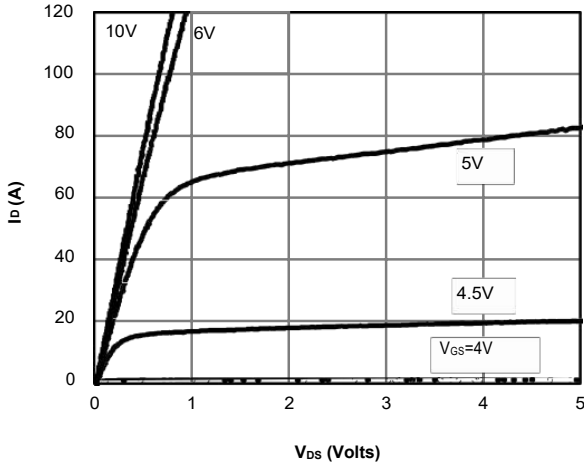

Figure 1: On-Region Characteristics (Note E)

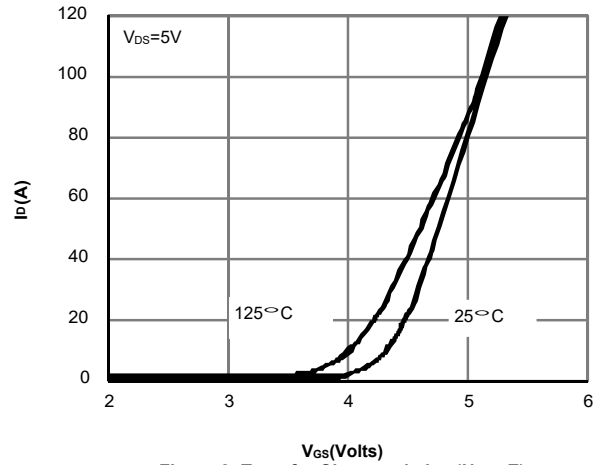

Figure 2: Transfer Characteristics (Note E)

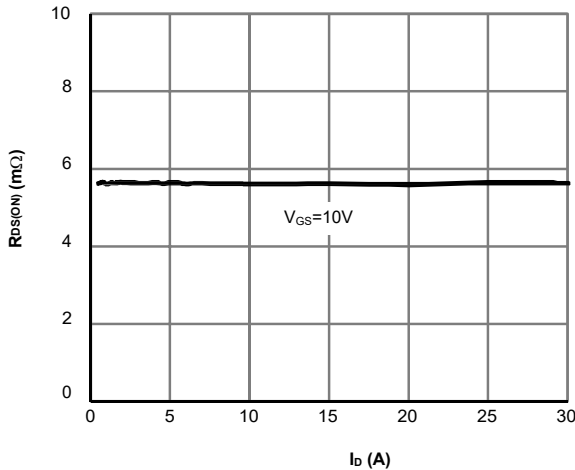

Figure 3: On-Resistance vs. Drain Current and Gate Voltage (Note E)

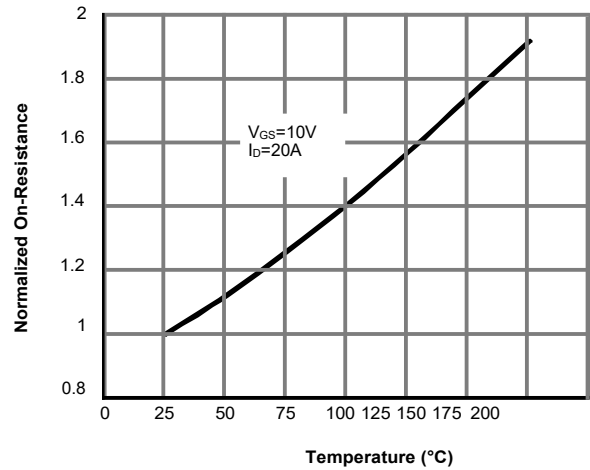

Figure 4: On-Resistance vs. Junction Temperature (Note E)

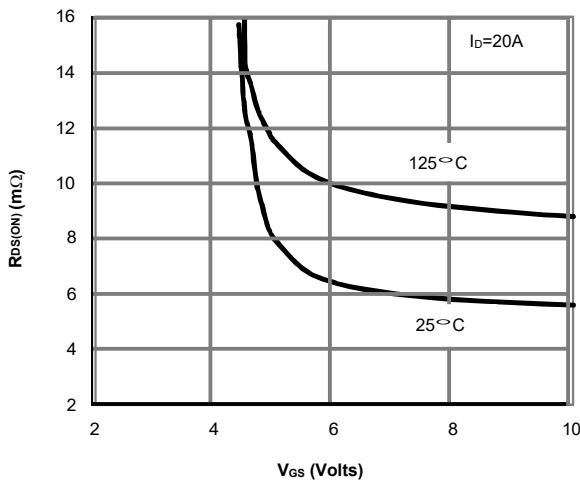

Figure 5: On-Resistance vs. Gate-Source Voltage (Note E)

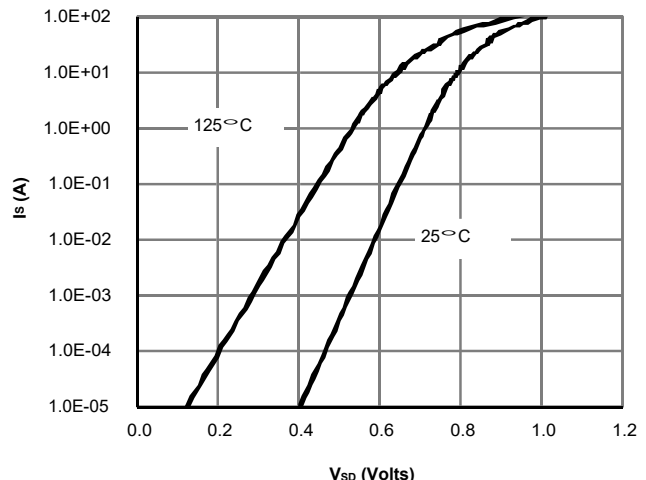
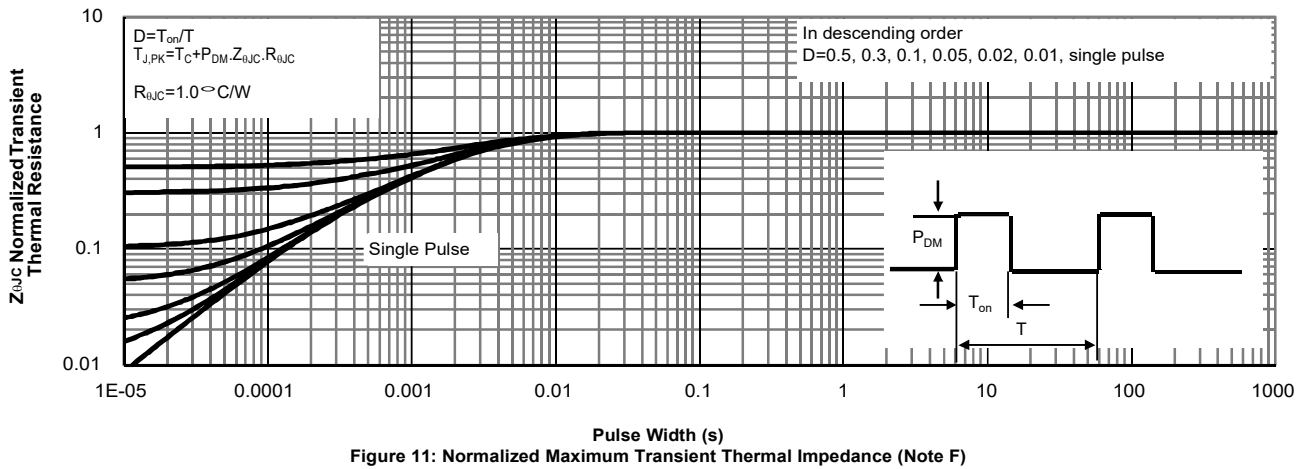
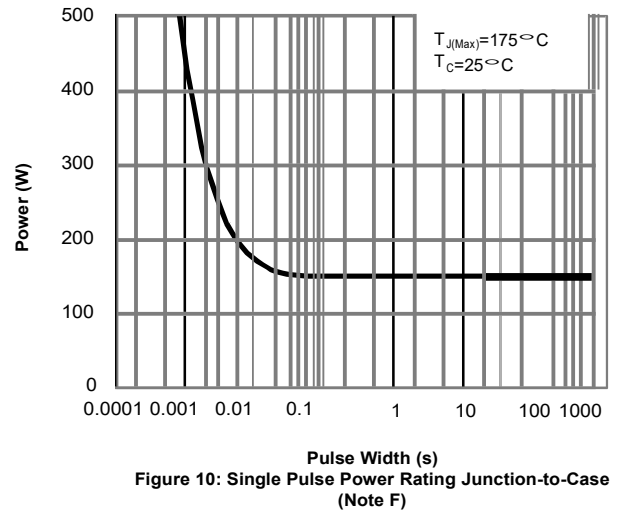
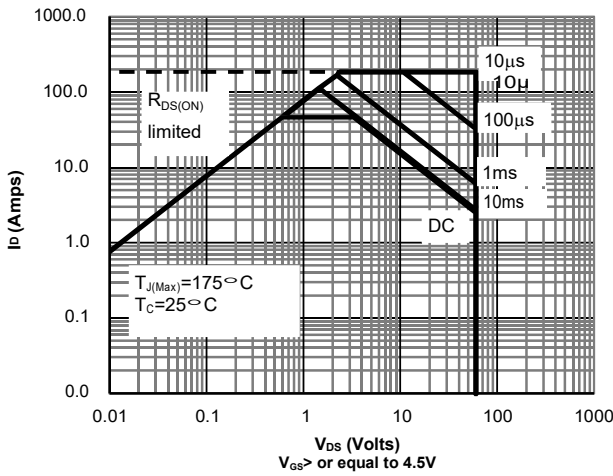
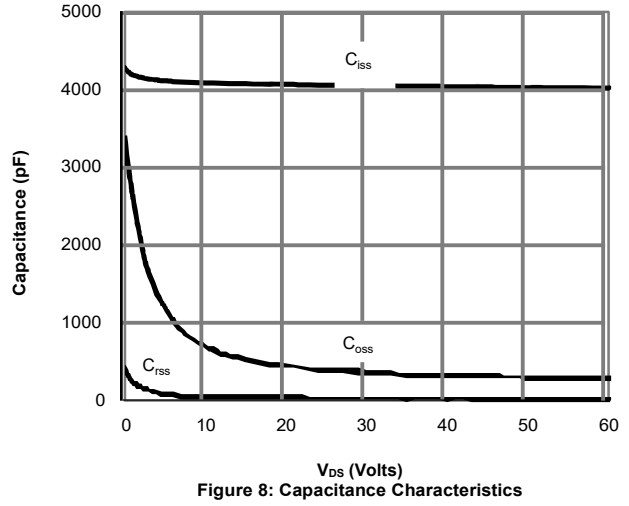
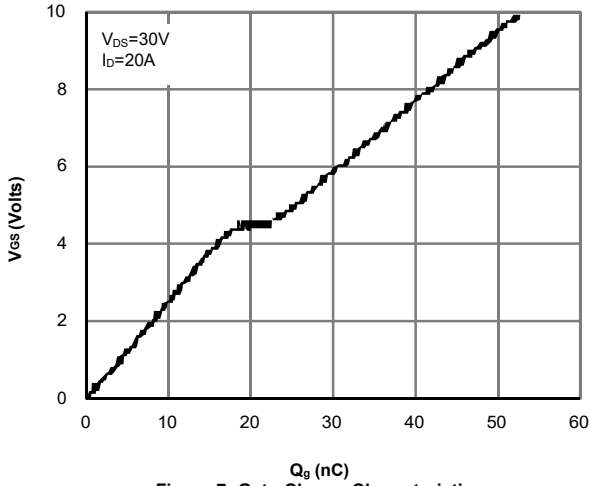

Figure 6: Body-Diode Characteristics (Note E)



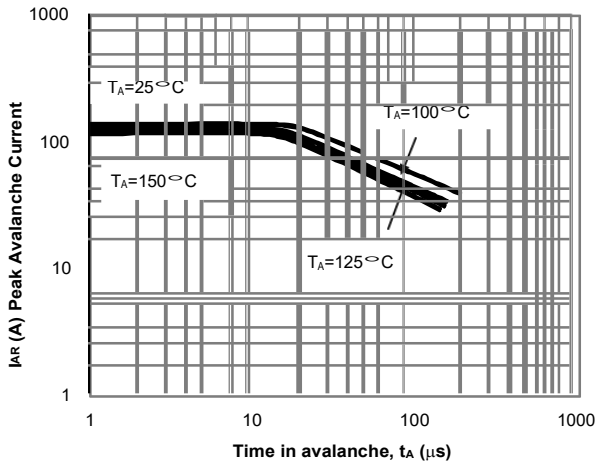

Figure 12: Single Pulse Avalanche capability (Note C)

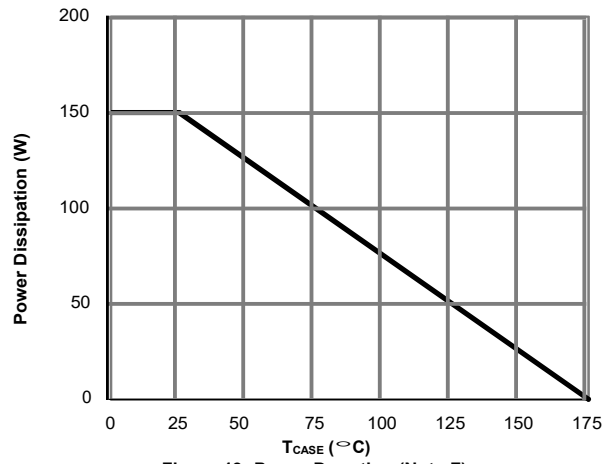

Figure 13: Power De-rating (Note F)

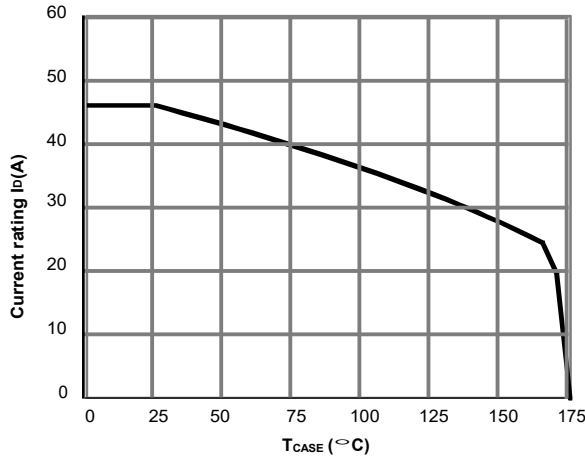

Figure 14: Current De-rating (Note F)

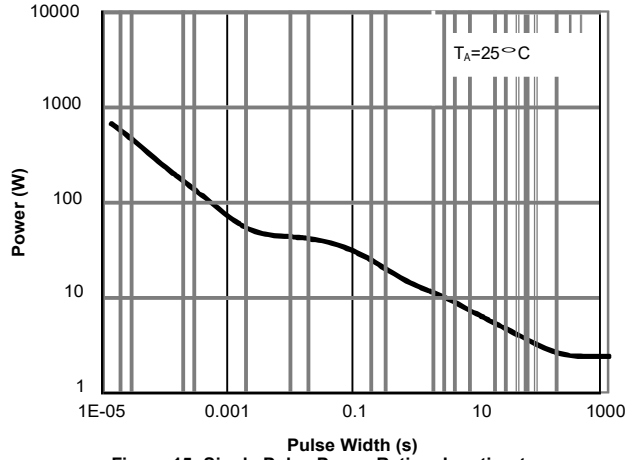

Figure 15: Single Pulse Power Rating Junction-to-Ambient (Note H)

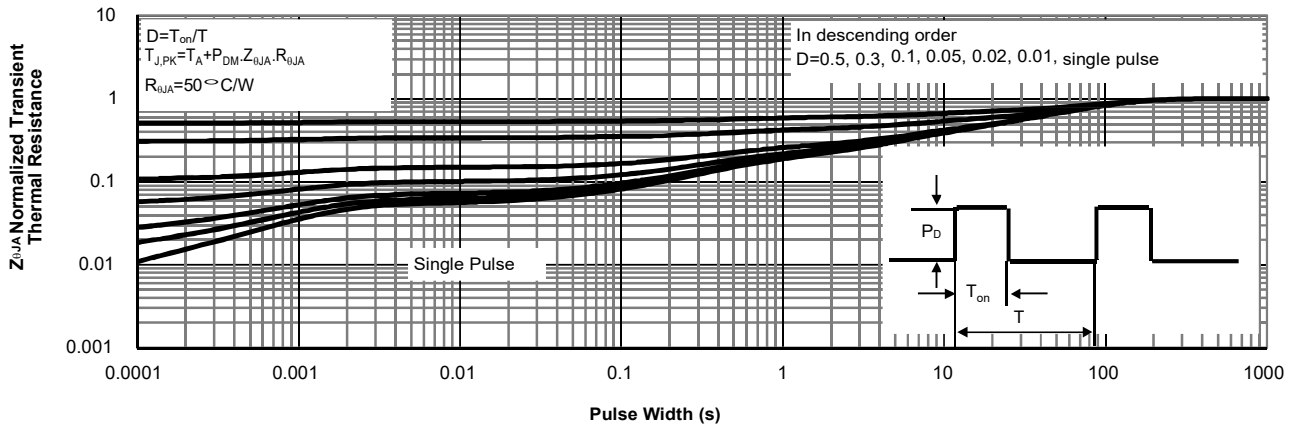
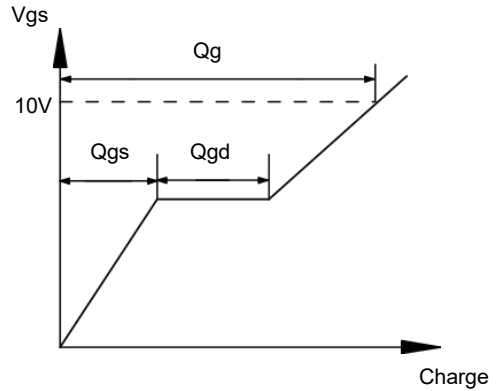
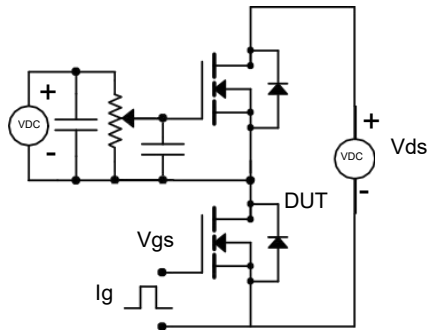
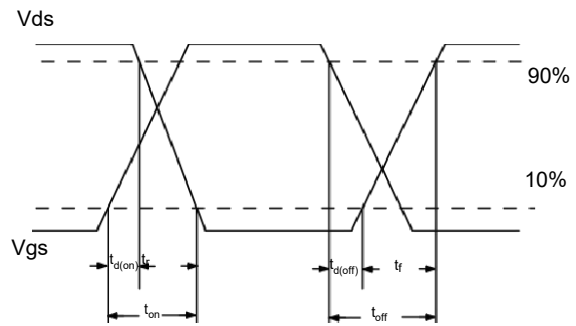
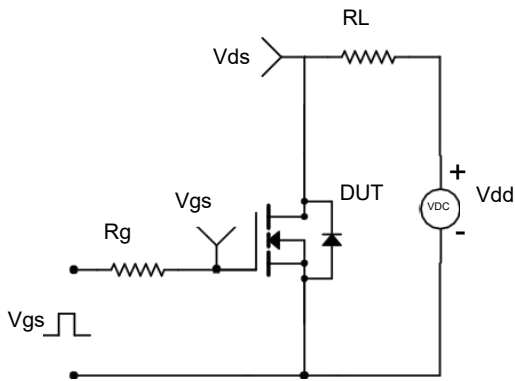

Figure 16: Normalized Maximum Transient Thermal Impedance (Note H)

Gate Charge Test Circuit & Waveform



Resistive Switching Test Circuit & Waveforms



Unclamped Inductive Switching (UIS) Test Circuit & Waveforms

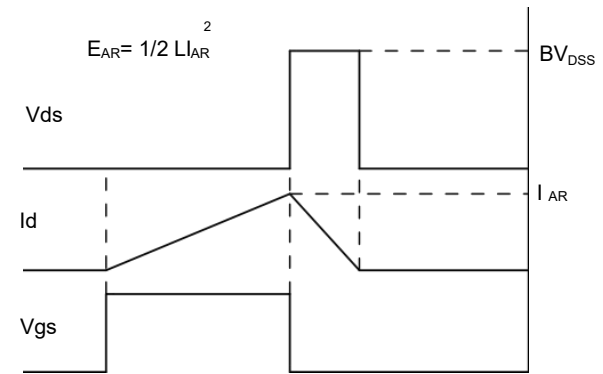
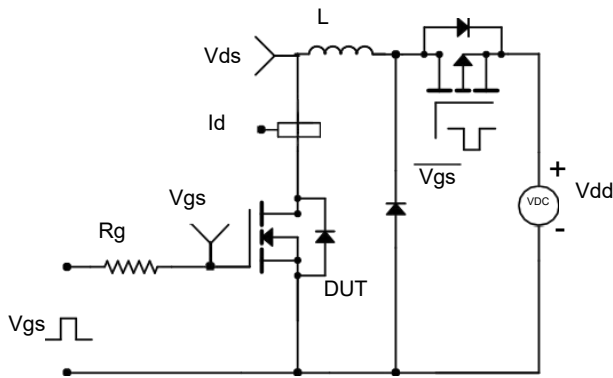

Diode Recovery Test Circuit & Waveforms

