

General Description

The MY80N06D uses advanced trench technology to provide excellent $R_{DS(ON)}$, low gate charge and operation with gate voltages as low as 4.5V. This device is suitable for use as a Battery protection or in other Switching application.



Features

V_{DSS}	60	V
I_D	80	A
$R_{DS(ON)}$ (at $V_{GS}=10V$)	<8	$m\Omega$
$R_{DS(ON)}$ (at $V_{GS}=4.5V$)	<13	$m\Omega$

Application

- Battery protection
- Load switch
- Uninterruptible power supply

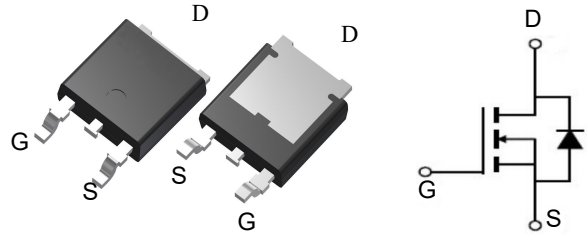

Package Marking and Ordering Information

Product ID	Pack	Marking	Qty(PCS)
MY80N06D	TO-252-2L	MY80N06D	2500

Absolute Maximum Ratings ($T_c=25^\circ\text{C}$ unless otherwise noted)

Parameter	Symbol	Value	Unit
Drain source voltage	V_{DS}	60	V
Gate source voltage	V_{GS}	± 20	V
Continuous drain current ¹⁾	I_D	80	A
Pulsed drain current ²⁾	I_D , pulse	180	A
Power dissipation ³⁾	P_D	125	W
Single pulsed avalanche energy ⁴⁾	EAS	30	mJ
Operation and storage temperature	T_{stg} , T_j	-55 to 150	$^\circ\text{C}$
Thermal resistance, junction-case	$R_{\theta JC}$	1	$^\circ\text{C/W}$
Thermal resistance, junction-ambient ⁵⁾	$R_{\theta JA}$	62	$^\circ\text{C/W}$

Electrical Characteristics ($T_j=25\text{ }^\circ\text{C}$, unless otherwise noted)

Symbol	Parameter	Test condition	Min.	Typ.	Max.	Unit
BV_{DSS}	Drain-source breakdown voltage	$V_{GS}=0\text{ V}$, $I_D=250\text{ }\mu\text{A}$	60	71		V
$V_{GS(th)}$	Gate threshold voltage	$V_{DS}=V_{GS}$, $I_D=250\text{ }\mu\text{A}$	2.0	3.0	4	V
$R_{DS(ON)}$	Drain-source on-state resistance	$V_{GS}=10\text{ V}$, $I_D=20\text{ A}$		6.5	8	m Ω
$R_{DS(ON)}$	Drain-source on-state resistance	$V_{GS}=4.5\text{ V}$, $I_D=10\text{ A}$		10	13	m Ω
I_{GSS}	Gate-source leakage current	$V_{GS}=20\text{ V}$			100	nA
		$V_{GS}=-20\text{ V}$			-100	
I_{DSS}	Drain-source leakage current	$V_{DS}=40\text{ V}$, $V_{GS}=0\text{ V}$			1	μA
C_{iss}	Input capacitance	$V_{GS}=0\text{ V}$, $V_{DS}=50\text{ V}$, $f=100\text{ kHz}$		1182.1		pF
C_{oss}	Output capacitance			199.5		pF
C_{rss}	Reverse transfer capacitance			4.1		pF
$t_{d(on)}$	Turn-on delay time	$V_{GS}=10\text{ V}$, $V_{DS}=50\text{ V}$, $R_G=2\text{ }\Omega$, $I_D=10\text{ A}$		17.9		ns
t_r	Rise time			4.0		ns
$t_{d(off)}$	Turn-off delay time			34.9		ns
t_f	Fall time			5.5		ns
Q_g	Total gate charge	$I_D=10\text{ A}$, $V_{DS}=50\text{ V}$, $V_{GS}=10\text{ V}$		18.4		nC
Q_{gs}	Gate-source charge			3.3		nC
Q_{gd}	Gate-drain charge			3.1		nC
$V_{plateau}$	Gate plateau voltage			2.8		V
I_S	Diode forward current		$V_{GS}<V_{th}$			60
I_{SP}	Pulsed source current				180	
V_{SD}	Diode forward voltage	$I_S=20\text{ A}$, $V_{GS}=0\text{ V}$			1.3	V
t_{rr}	Reverse recovery time	$I_S=10\text{ A}$, $di/dt=100\text{ A}/\mu\text{s}$		41.8		ns
Q_{rr}	Reverse recovery charge				36.1	nC
I_{rrm}	Peak reverse recovery current				1.4	A

Note

- 1) Calculated continuous current based on maximum allowable junction temperature.
- 2) Repetitive rating; pulse width limited by max. junction temperature.
- 3) P_d is based on max. junction temperature, using junction-case thermal resistance.
- 4) $V_{DD}=50\text{ V}$, $R_G=50\text{ }\Omega$, $L=0.3\text{ mH}$, starting $T_j=25\text{ }^\circ\text{C}$.
- 5) The value of $R_{\theta JA}$ is measured with the device mounted on 1 in 2 FR-4 board with 2oz. Copper, in a still air environment with $T_a=25\text{ }^\circ\text{C}$.

Typical Characteristics

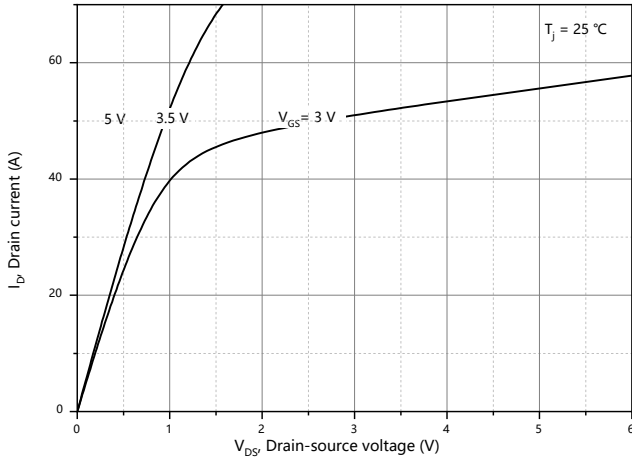

Figure 1, Typ. output characteristics

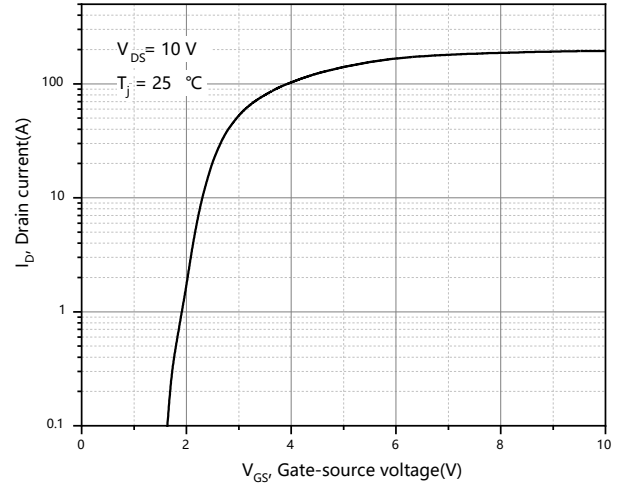

Figure 2, Typ. transfer characteristics

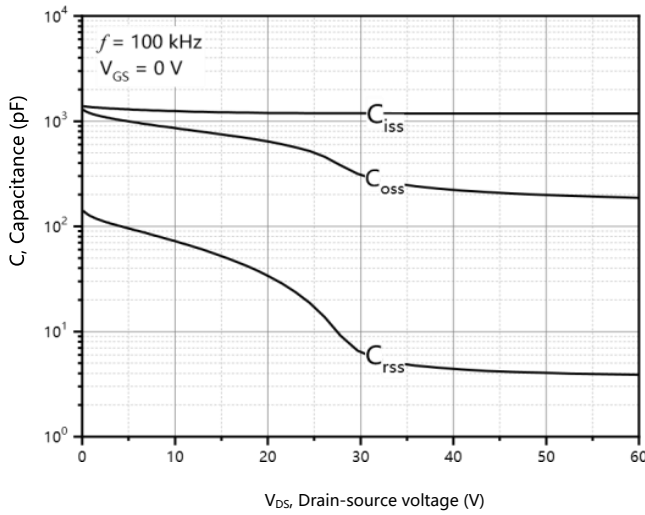

Figure 3, Typ. capacitances

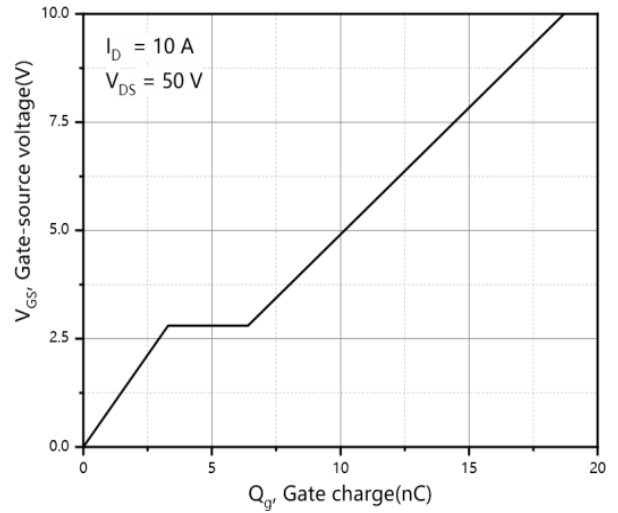

Figure 4, Typ. gate charge

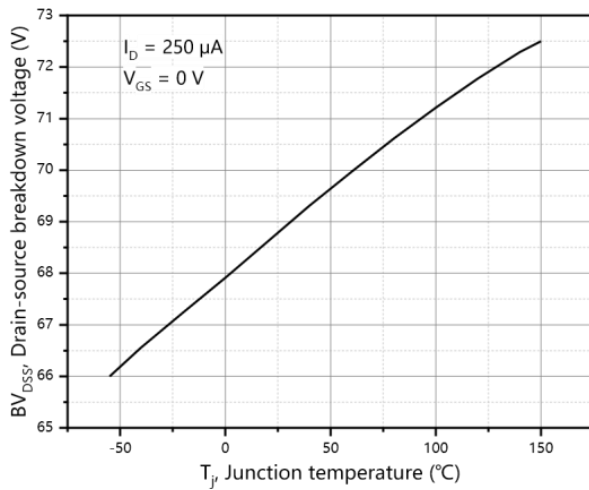

Figure 5, Drain-source breakdown voltage

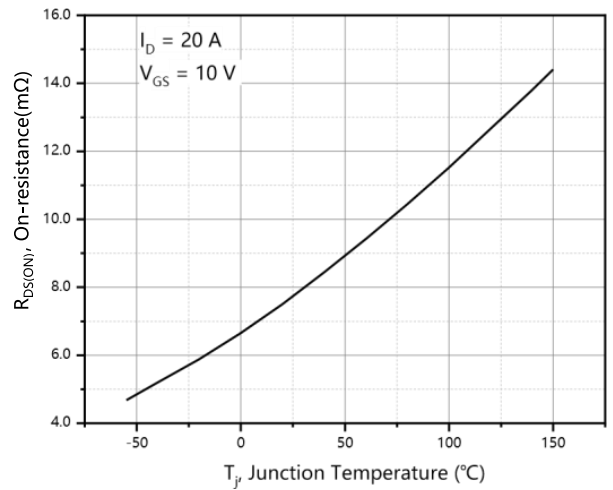

Figure 6, Drain-source on-state resistance

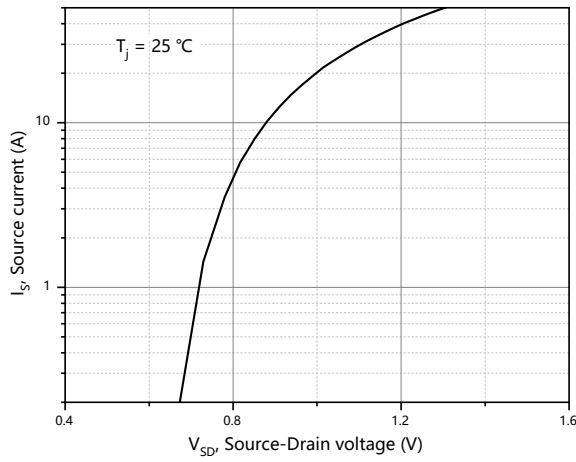

Figure 7, Forward characteristic of body diode

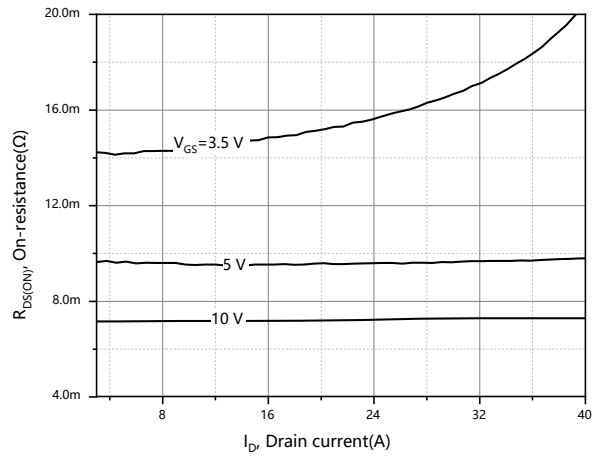

Figure 8, Drain-source on-state resistance

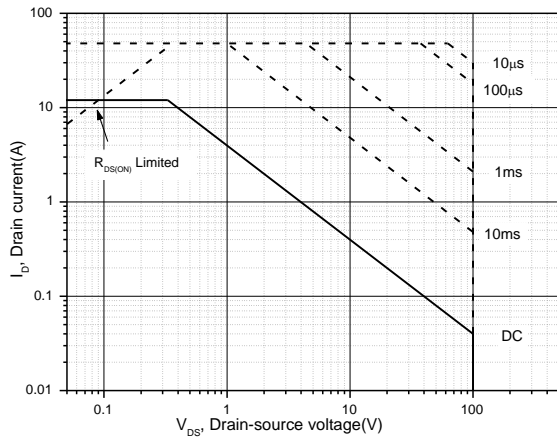

Figure 9, Safe operation area $T_C=25\text{ }^\circ\text{C}$

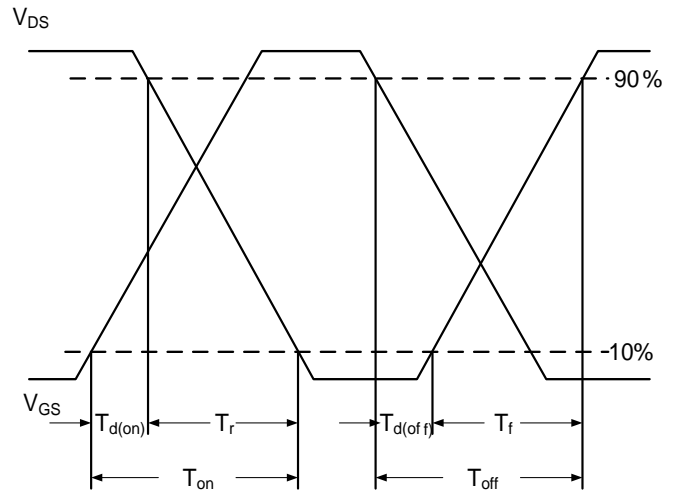

Fig.10 Switching Time Waveform

$$EAS = \frac{1}{2} L \times I_{AS}^2 \times \frac{BV_{DSS}}{BV_{DSS} - V_{DD}}$$

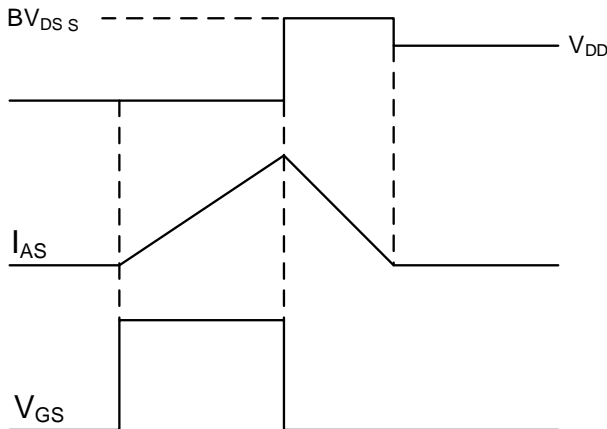
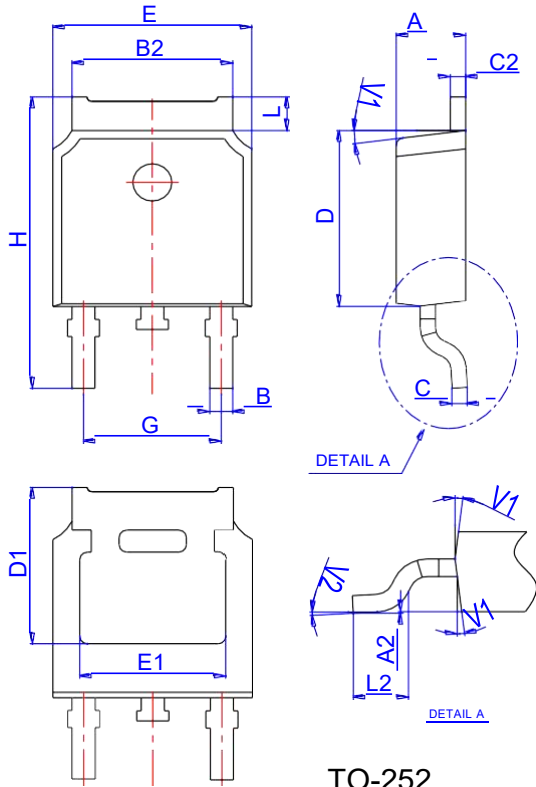

Fig.11 Unclamped Inductive Switching Waveform

Package Mechanical Data-TO-252-JQ Single



Ref.	Dimensions					
	Millimeters			Inches		
	Min.	Typ.	Max.	Min.	Typ.	Max.
A	2.10		2.50	0.083		0.098
A2	0		0.10	0		0.004
B	0.66		0.86	0.026		0.034
B2	5.18		5.48	0.202		0.216
C	0.40		0.60	0.016		0.024
C2	0.44		0.58	0.017		0.023
D	5.90		6.30	0.232		0.248
D1	5.30REF			0.209REF		
E	6.40		6.80	0.252		0.268
E1	4.63			0.182		
G	4.47		4.67	0.176		0.184
H	9.50		10.70	0.374		0.421
L	1.09		1.21	0.043		0.048
L2	1.35		1.65	0.053		0.065
V1		7°			7°	
V2	0°		6°	0°		6°

Reel Specification-TO-252

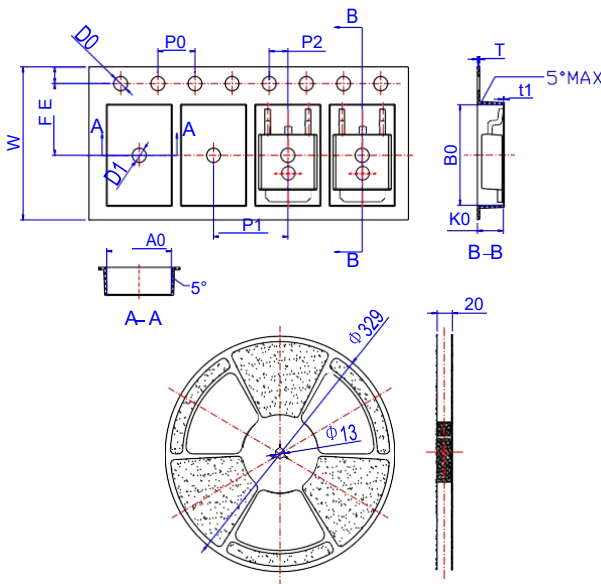

Ref.	Dimensions					
	Millimeters			Inches		
	Min.	Typ.	Max.	Min.	Typ.	Max.
W	15.90	16.00	16.10	0.626	0.630	0.634
E	1.65	1.75	1.85	0.065	0.069	0.073
F	7.40	7.50	7.60	0.291	0.295	0.299
D0	1.40	1.50	1.60	0.055	0.059	0.063
D1	1.40	1.50	1.60	0.055	0.059	0.063
P0	3.90	4.00	4.10	0.154	0.157	0.161
P1	7.90	8.00	8.10	0.311	0.315	0.319
P2	1.90	2.00	2.10	0.075	0.079	0.083
A0	6.85	6.90	7.00	0.270	0.271	0.276
B0	10.45	10.50	10.60	0.411	0.413	0.417
K0	2.68	2.78	2.88	0.105	0.109	0.113
T	0.24		0.27	0.009		0.011
t1	0.10			0.004		
10P0	39.80	40.00	40.20	1.567	1.575	1.583