

## General Description

The MY7534 uses advanced trench technology to provide excellent  $R_{DS(ON)}$ , low gate charge and operation with gate voltages as low as 4.5V. This device is suitable for use as a Battery protection or in other Switching application.

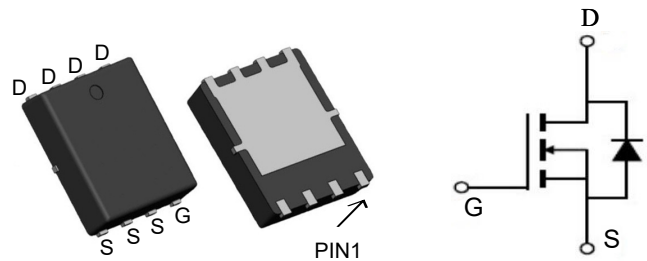


## Features

$V_{DSS}$	30	V
$I_D$	40	A
$R_{DS(ON)}$ (at $V_{GS} = 10V$ )	7.5	$m\Omega$
$R_{DS(ON)}$ (at $V_{GS} = 4.5V$ )	10	$m\Omega$

## Application

- Battery protection
- Load switch
- Uninterruptible power supply



## Package Marking and Ordering Information

Product ID	Pack	Marking	Qty(PCS)
MY7534	PDFN3*3-8	MY7534	5000

## Absolute Maximum Ratings ( $T_C=25^\circ\text{C}$ unless otherwise noted)

Symbol	Parameter	Rating	Units
$V_{DS}$	Drain-Source Voltage	30	V
$V_{GS}$	Gate-Source Voltage	$\pm 20$	V
$I_D@T_A=25^\circ\text{C}$	Continuous Drain Current, $V_{GS} @ 10V^1$	40	A
$I_D@T_A=70^\circ\text{C}$	Continuous Drain Current, $V_{GS} @ 10V^1$	30	A
$I_{DM}$	Pulsed Drain Current <sup>2</sup>	120	A
EAS	Single Pulse Avalanche Energy <sup>3</sup>	39	mJ
$I_{AS}$	Avalanche Current	50	A
$P_D@T_A=25^\circ\text{C}$	Total Power Dissipation <sup>4</sup>	18	W
$T_{STG}$	Storage Temperature Range	-55 to 150	$^\circ\text{C}$
$T_J$	Operating Junction Temperature Range	-55 to 150	$^\circ\text{C}$
$R_{\theta JA}$	Thermal Resistance Junction-ambient <sup>1</sup>	70	$^\circ\text{C/W}$
$R_{\theta JC}$	Thermal Resistance Junction-Case <sup>1</sup>	4.32	$^\circ\text{C/W}$

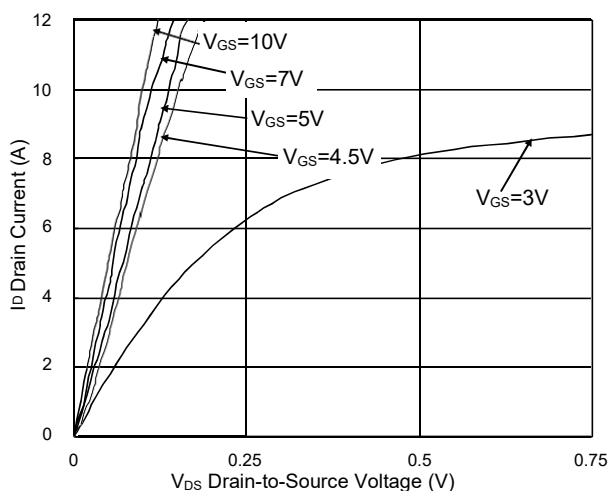
**Electrical Characteristics (T<sub>J</sub>=25 °C, unless otherwise noted)**

Symbol	Parameter	Conditions	Min.	Typ.	Max.	Unit
BV <sub>DSS</sub>	Drain-Source Breakdown Voltage	V <sub>GS</sub> =0V, I <sub>D</sub> =250uA	30	---	---	V
ΔBV <sub>DSS</sub> /ΔT <sub>J</sub>	BVDSS Temperature Coefficient	Reference to 25°C, I <sub>D</sub> =1mA	---	0.027	---	V/°C
R <sub>DS(ON)</sub>	Static Drain-Source On-Resistance <sup>2</sup>	V <sub>GS</sub> =10V, I <sub>D</sub> =10A	---	7.5	9	mΩ
		V <sub>GS</sub> =4.5V, I <sub>D</sub> =8A	---	10	14	
V <sub>GS(th)</sub>	Gate Threshold Voltage		1.0	---	2.5	V
ΔV <sub>GS(th)</sub>	V <sub>GS(th)</sub> Temperature Coefficient	V <sub>GS</sub> =V <sub>DS</sub> , I <sub>D</sub> =250uA	---	-5.8	---	mV/°C
I <sub>DSS</sub>	Drain-Source Leakage Current	V <sub>DS</sub> =24V, V <sub>GS</sub> =0V, T <sub>J</sub> =25 °C	---	---	1	uA
		V <sub>DS</sub> =24V, V <sub>GS</sub> =0V, T <sub>J</sub> =55°C	---	---	5	
I <sub>GSS</sub>	Gate-Source Leakage Current	V <sub>GS</sub> =±20V, V <sub>DS</sub> =0V	---	---	±100	nA
g <sub>fs</sub>	Forward Transconductance	V <sub>DS</sub> =5V, I <sub>D</sub> =10A	---	---	---	S
R <sub>g</sub>	Gate Resistance	V <sub>DS</sub> =0V, V <sub>GS</sub> =0V, f=1MHz	---	1.7	---	Ω
Q <sub>g</sub>	Total Gate Charge (4.5V)	V <sub>DS</sub> =15V, V <sub>GS</sub> =4.5V, I <sub>D</sub> =10A	---	12.8	---	nC
Q <sub>gs</sub>	Gate-Source Charge		---	3.3	---	
Q <sub>gd</sub>	Gate-Drain Charge		---	6.5	---	
T <sub>d(on)</sub>	Turn-On Delay Time	V <sub>DD</sub> =15V, V <sub>GS</sub> =10V, R <sub>G</sub> =3.3 I <sub>D</sub> =10A	---	4.5	---	ns
T <sub>r</sub>	Rise Time		---	10.8	---	
T <sub>d(off)</sub>	Turn-Off Delay Time		---	25.5	---	
T <sub>f</sub>	Fall Time		---	9.6	---	
C <sub>iss</sub>	Input Capacitance	V <sub>DS</sub> =15V, V <sub>GS</sub> =0V, f=1MHz	---	505	---	pF
C <sub>oss</sub>	Output Capacitance		---	137	---	
C <sub>rss</sub>	Reverse Transfer Capacitance		---	22	---	
I <sub>S</sub>	Continuous Source Current <sup>1,5</sup>	V <sub>G</sub> =V <sub>D</sub> =0V, Force Current	---	---	50	A
I <sub>SM</sub>	Pulsed Source Current <sup>2,5</sup>		---	---	120	A
V <sub>SD</sub>	Diode Forward Voltage <sup>2</sup>	V <sub>GS</sub> =0V, I <sub>S</sub> =1A, T <sub>J</sub> =25°C	---	---	1.2	V
t <sub>rr</sub>	Reverse Recovery Time	I <sub>F</sub> =10A, di/dt=100A/μs, T <sub>J</sub> =25°C	---	12.5	---	nS
Q <sub>rr</sub>	Reverse Recovery Charge		---	5	---	nC

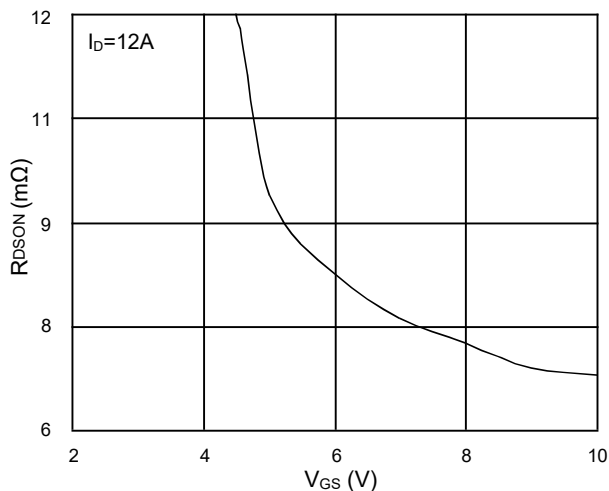
Note :

- The data tested by surface mounted on a 1 inch<sup>2</sup>FR-4 board with 2OZ copper.
- The data tested by pulsed, pulse width ≤ 300us, duty cycle ≤ 2%
- The EAS data shows Max. rating. The test condition is V<sub>DD</sub>=25V, V<sub>GS</sub>=10V, L=0.1mH, I<sub>AS</sub>=35A
- The power dissipation is limited by 150°C junction temperature 5.The data is theoretically the same as I<sub>D</sub> and I<sub>DM</sub>, in real applications, should be limited by total power dissipation.

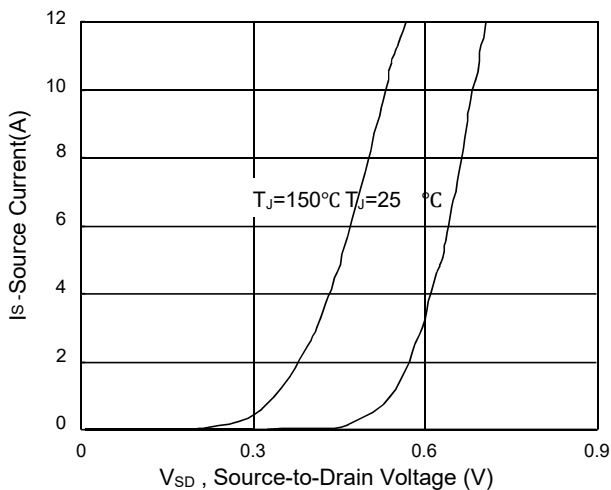
**Typical Characteristics**



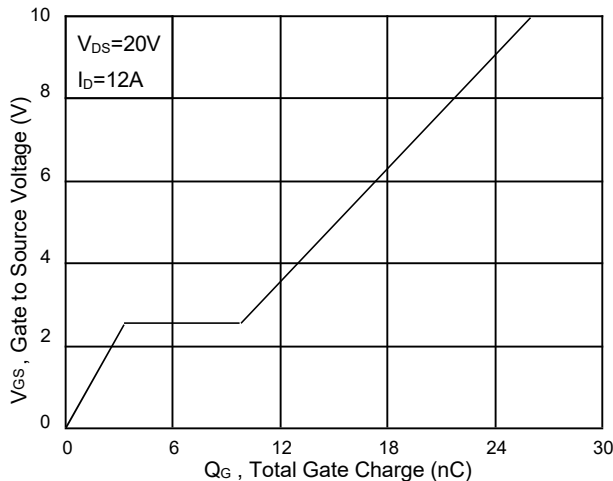
**Fig.1 Typical Output Characteristics**



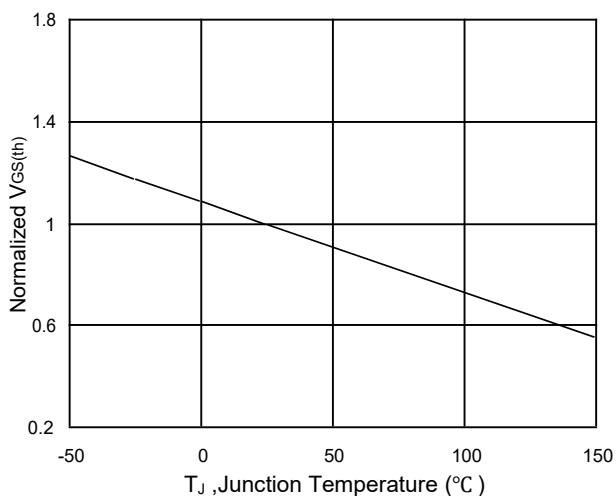
**Fig.2 On-Resistance vs. G-S Voltage**



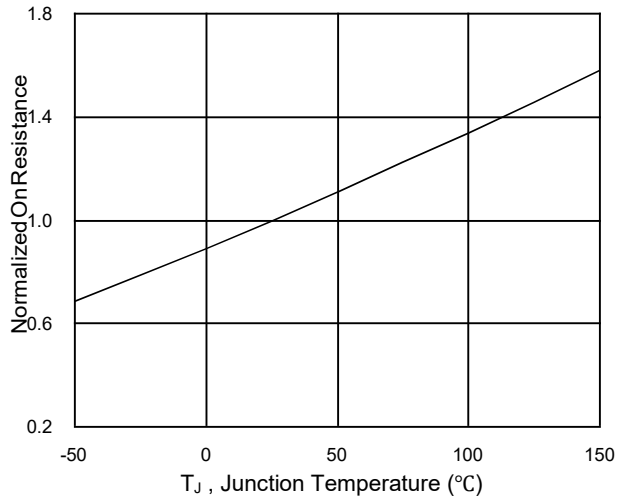
**Fig.3 Forward Characteristics of Reverse**



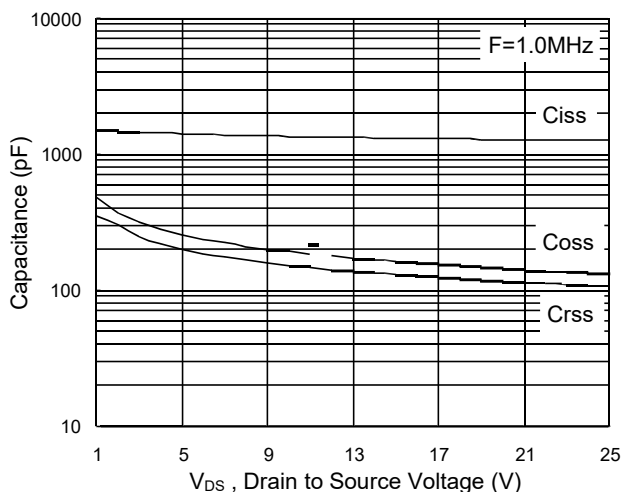
**Fig.4 Gate-Charge Characteristics**



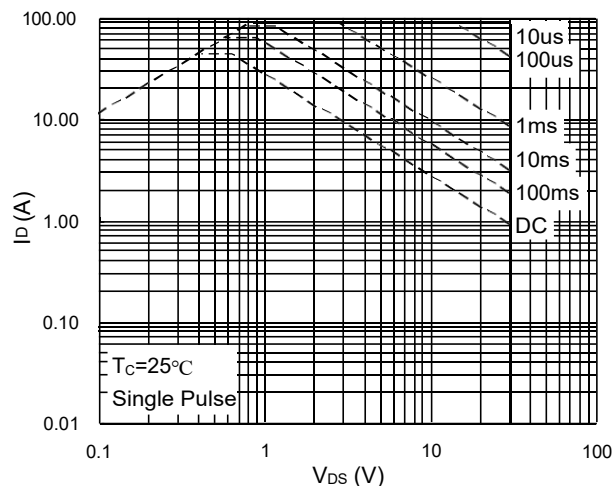
**Fig.5 Normalized  $V_{GS(th)}$  vs.  $T_J$**



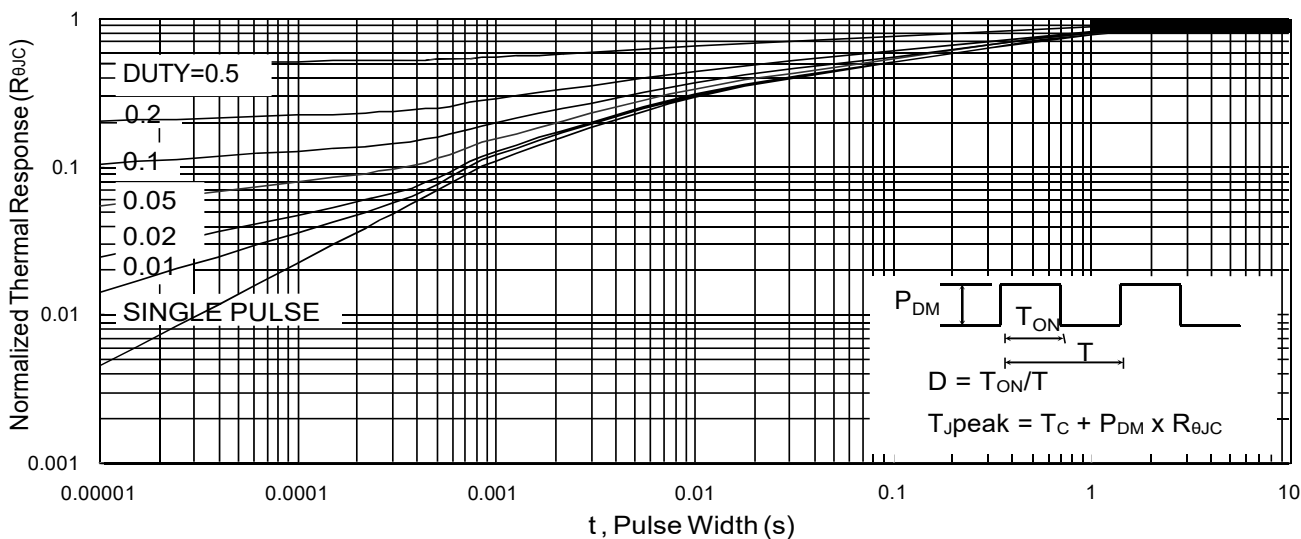
**Fig.6 Normalized  $R_{DS(on)}$  vs.  $T_J$**



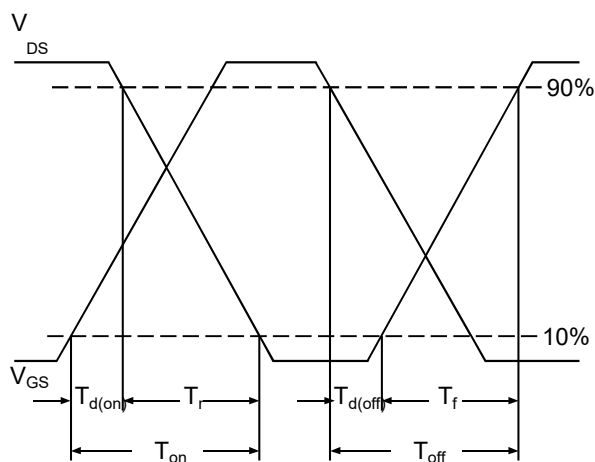
**Fig.7 Capacitance**



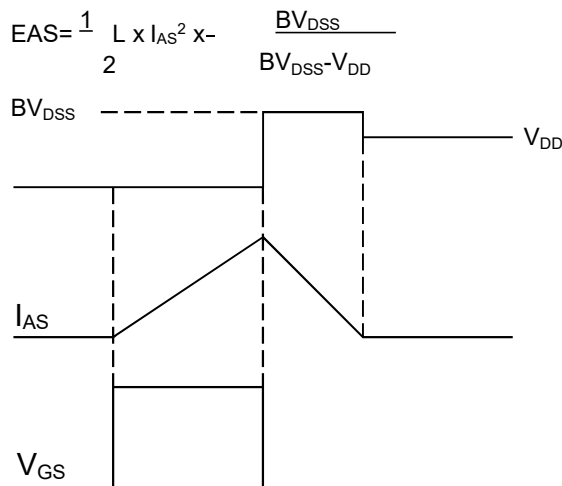
**Fig.8 Safe Operating Area**



**Fig.9 Normalized Maximum Transient Thermal Impedance**

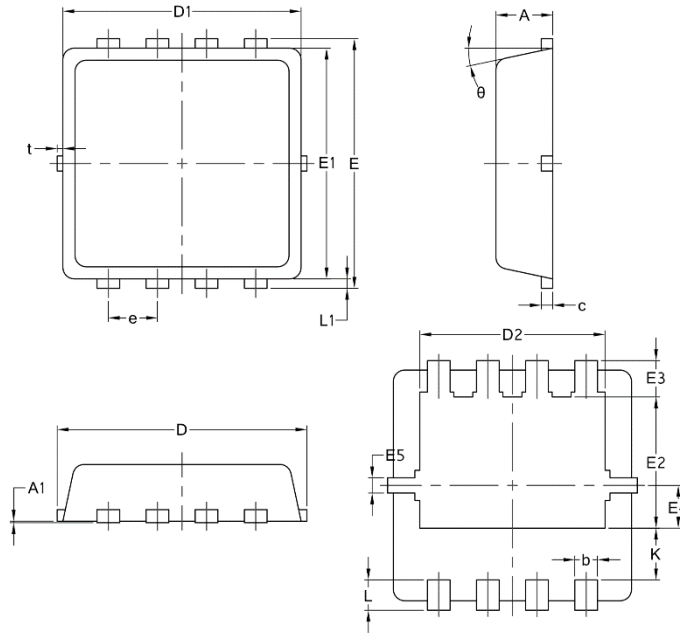


**Fig.10 Switching Time Waveform**



**Fig.11 Unclamped Inductive Switching Waveform**

**Package Mechanical Data-DFN3\*3-8L-JQ Single**



Symbol	Common		
	mm		
	Mim	Nom	Max
A	0.70	0.75	0.85
A1	/	/	0.05
b	0.20	0.30	0.40
c	0.10	0.152	0.25
D	3.15	3.30	3.45
D1	3.00	3.15	3.25
D2	2.29	2.45	2.65
E	3.15	3.30	3.45
E1	2.90	3.05	3.20
E2	1.54	1.74	1.94
E3	0.28	0.48	0.65
E4	0.37	0.57	0.77
E5	0.10	0.20	0.30
e	0.60	0.65	0.70
K	0.59	0.69	0.89
L	0.30	0.40	0.50
L1	0.06	0.125	0.20
t	0	0.075	0.13
Φ	10	12	14