

General Description

The MY3P50D uses advanced trench technology to provide excellent $R_{DS(ON)}$, low gate charge and operation with gate voltages as low as 10V. This device is suitable for use as a Battery protection or in other Switching application.



Features

V_{DSS}	-500	V
I_D	-3	A
$P_D(T_A=25^\circ C)$	2.5	W
$R_{DS(ON)}(at V_{GS}=4.5V)$	< 4.9	Ω

Application

- Battery protection
- Load switch
- Uninterruptible power supply

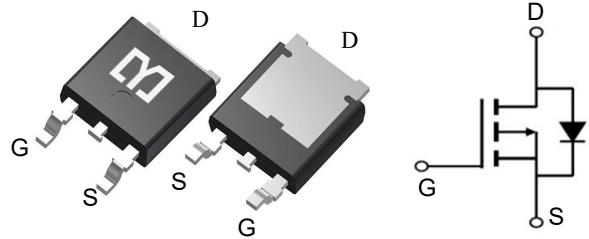

Package Marking and Ordering Information

Product ID	Pack	Marking	Qty(PCS)
MY3P50D	TO-252-2L	MY3P50D	2500

Absolute Maximum Ratings ($T_A=25^\circ C$ unless otherwise noted)

Symbol	Parameter	Rating	Units
V_{DS}	Drain-Source Voltage	- 500	V
V_{GS}	Gate-Source Voltage	± 30	V
$I_D@T_A=25^\circ C$	Drain Current ³ , V_{GS} @ 10V	- 3.0	A
$I_D@T_A=70^\circ C$	Drain Current ³ , V_{GS} @ 10V	- 1.33	A
IDM	Pulsed Drain Current ¹	-8.4	A
$P_D@T_A=25^\circ C$	Total Power Dissipation	2.5	W
	Linear Derating Factor	0.4	W/ $^\circ C$
TSTG	Storage Temperature Range	-55 to 150	$^\circ C$
T_J	Operating Junction Temperature Range	-55 to 150	$^\circ C$
Rthj-a	Maximum Thermal Resistance, Junction-ambient ³	50	$^\circ C/W$

Electrical Characteristics (T_A=25 °C, unless otherwise noted)

Symbol	Parameter	Test Conditions	Min	Typ	Max	Unit
Off Characteristics						
BV _{DSS}	Drain-Source Breakdown Voltage	V _{GS} = 0 V, I _D = -250 μA	-500	--	--	V
ΔBV _{DSS} / ΔT _J	Breakdown Voltage Temperature Coefficient	I _D = -250 μA, Referenced to 25°C	--	0.42	--	V/°C
I _{DSS}	Zero Gate Voltage Drain Current	V _{DS} = -500 V, V _{GS} = 0 V	--	--	-1	μA
		V _{DS} = -400 V, T _C = 125°C	--	--	-10	μA
I _{GSSF}	Gate-Body Leakage Current, Forward	V _{GS} = -30 V, V _{DS} = 0 V	--	--	-100	nA
I _{GSSR}	Gate-Body Leakage Current, Reverse	V _{GS} = 30 V, V _{DS} = 0 V	--	--	100	nA
On Characteristics						
V _{GS(th)}	Gate Threshold Voltage	V _{DS} = V _{GS} , I _D = -250 μA	-3.0	--	-5.0	V
R _{DS(on)}	Static Drain-Source On-Resistance	V _{GS} = -10 V, I _D = -1.05 A	--	3.9	4.9	Ω
g _{FS}	Forward Transconductance	V _{DS} = -50 V, I _D = -1.05 A	--	2.1	--	S
Dynamic Characteristics						
C _{iss}	Input Capacitance	V _{DS} = -25 V, V _{GS} = 0 V, f = 1.0 MHz	--	510	660	pF
C _{oss}	Output Capacitance		--	70	90	pF
C _{rss}	Reverse Transfer Capacitance		--	9.5	12	pF
Switching Characteristics						
t _{d(on)}	Turn-On Delay Time	V _{DD} = -250 V, I _D = -2.7 A, R _G = 25 Ω (Note 4)	--	12	35	ns
t _r	Turn-On Rise Time		--	56	120	ns
t _{d(off)}	Turn-Off Delay Time		--	35	80	ns
t _f	Turn-Off Fall Time		--	45	100	ns
Q _g	Total Gate Charge	V _{DS} = -400 V, I _D = -2.7 A, V _{GS} = -10 V (Note 4)	--	18	23	nC
Q _{gs}	Gate-Source Charge		--	3.6	--	nC
Q _{gd}	Gate-Drain Charge		--	9.2	--	nC
Drain-Source Diode Characteristics and Maximum Ratings						
I _S	Maximum Continuous Drain-Source Diode Forward Current		--	--	-2.1	A
I _{SM}	Maximum Pulsed Drain-Source Diode Forward Current		--	--	-8.4	A
V _{SD}	Drain-Source Diode Forward Voltage	V _{GS} = 0 V, I _S = -2.1 A	--	--	-5.0	V
t _{rr}	Reverse Recovery Time	V _{GS} = 0 V, I _S = -2.7 A, dI _F / dt = 100 A/μs	--	270	--	ns
Q _{rr}	Reverse Recovery Charge		--	1.5	--	μC

Notes:

1. Repetitive Rating : Pulse width limited by maximum junction temperature
2. L = 102mH, I_{AS} = -2.1A, V_{DD} = -50V, R_G = 25 Ω, Starting T_J = 25°C
3. I_{SD} ≤ -2.7A, di/dt ≤ 200A/μs, V_{DD} ≤ BV_{DSS}, Starting T_J = 25°C
4. Essentially independent of operating temperature

Typical Characteristics

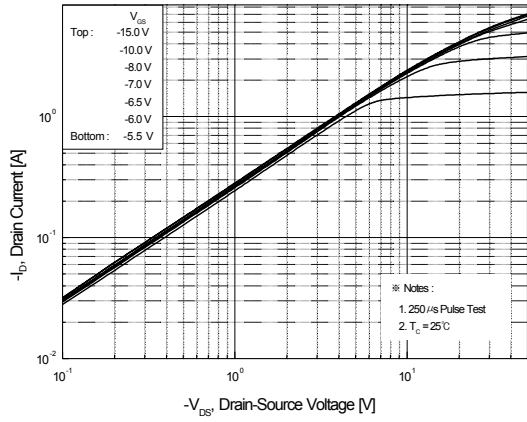

Figure 1. On-Region Characteristics

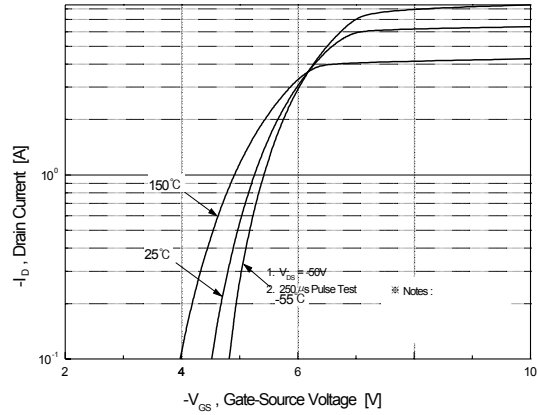

Figure 2. Transfer Characteristics

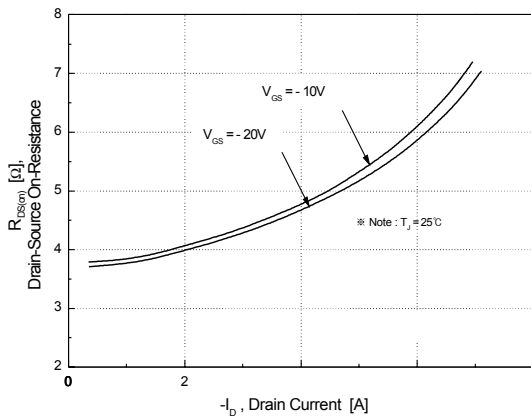

Figure 3. On-Resistance Variation vs. Drain Current and Gate Voltage

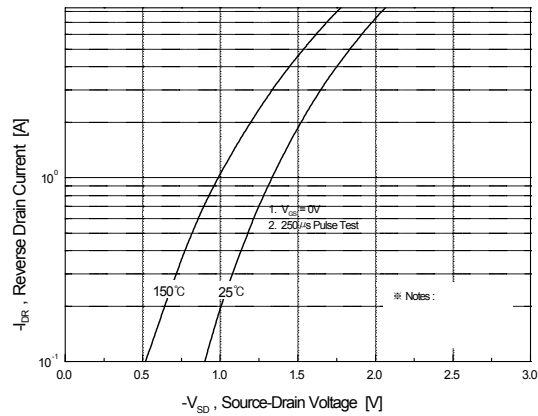

Figure 4. Body Diode Forward Voltage Variation vs. Source Current and Temperature

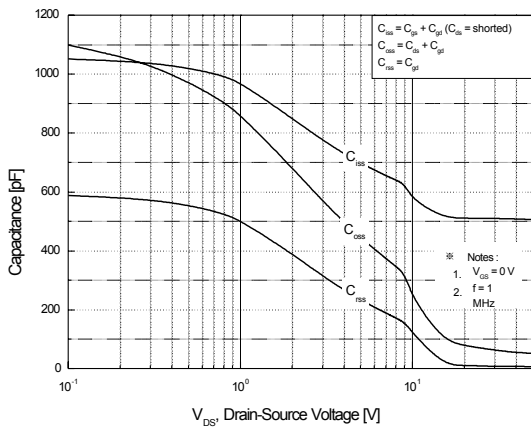

Figure 5. Capacitance Characteristics

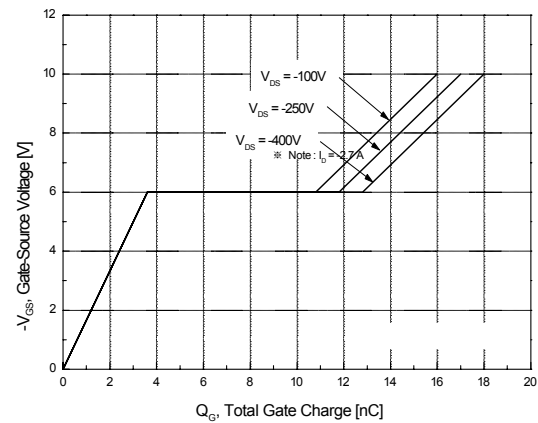

Figure 6. Gate Charge Characteristics

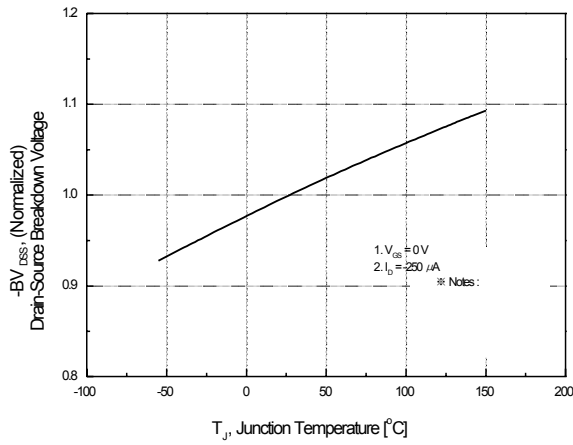

Figure 7. Breakdown Voltage Variation vs. Temperature

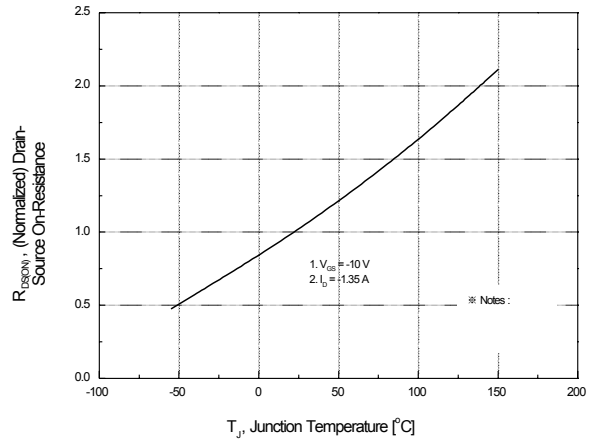

Figure 8. On-Resistance Variation vs. Temperature

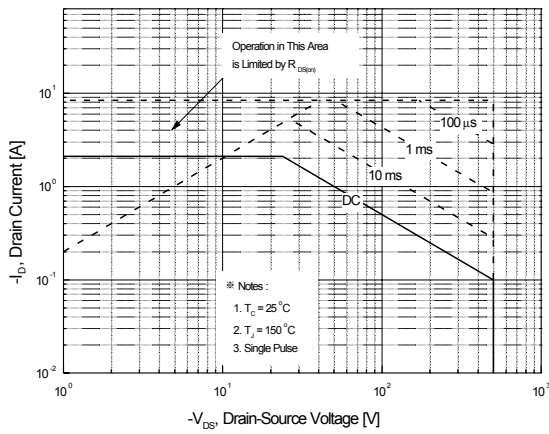

Figure 9. Maximum Safe Operating Area

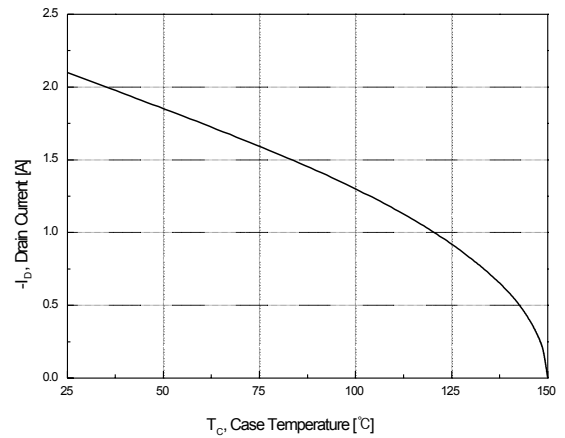

Figure 10. Maximum Drain Current vs. Case Temperature

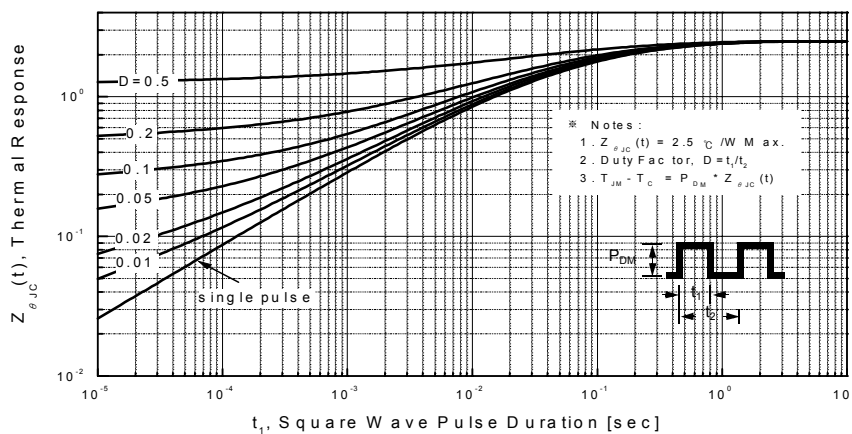
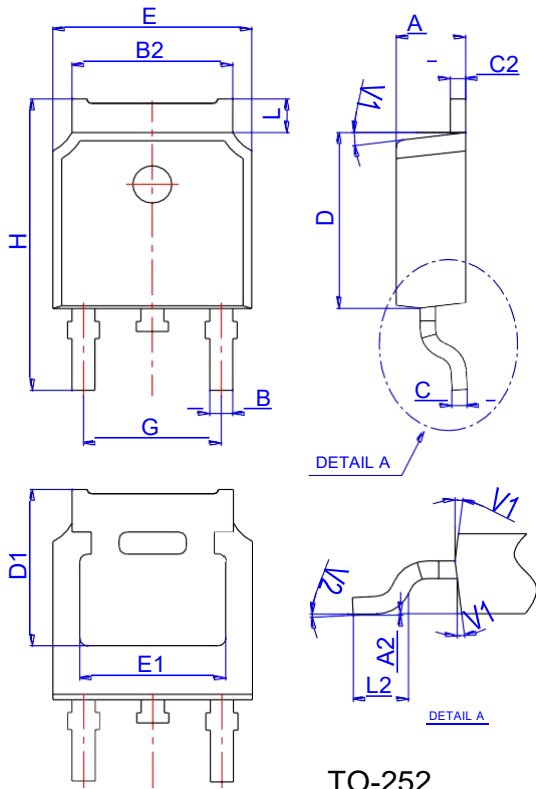

Figure 11. Transient Thermal Response Curve

Package Mechanical Data-TO-252-JQ Single



Ref.	Dimensions					
	Millimeters			Inches		
	Min.	Typ.	Max.	Min.	Typ.	Max.
A	2.10		2.50	0.083		0.098
A2	0		0.10	0		0.004
B	0.66		0.86	0.026		0.034
B2	5.18		5.48	0.202		0.216
C	0.40		0.60	0.016		0.024
C2	0.44		0.58	0.017		0.023
D	5.90		6.30	0.232		0.248
D1	5.30REF			0.209REF		
E	6.40		6.80	0.252		0.268
E1	4.63			0.182		
G	4.47		4.67	0.176		0.184
H	9.50		10.70	0.374		0.421
L	1.09		1.21	0.043		0.048
L2	1.35		1.65	0.053		0.065
V1		7°			7°	
V2	0°		6°	0°		6°

Reel Specification-TO-252

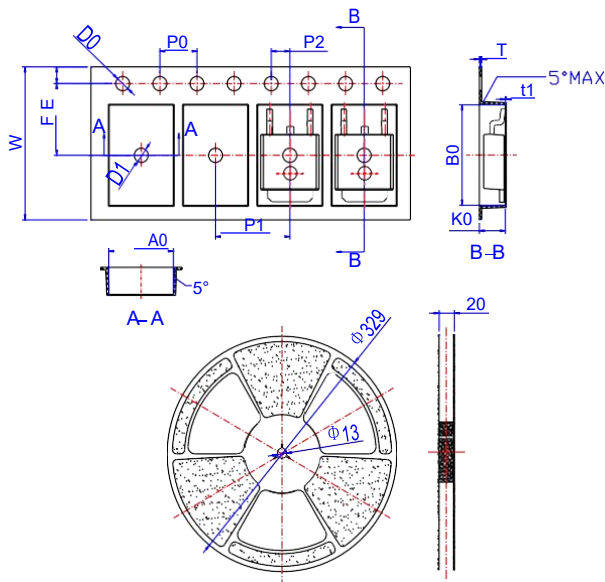

Ref.	Dimensions					
	Millimeters			Inches		
	Min.	Typ.	Max.	Min.	Typ.	Max.
W	15.90	16.00	16.10	0.626	0.630	0.634
E	1.65	1.75	1.85	0.065	0.069	0.073
F	7.40	7.50	7.60	0.291	0.295	0.299
D0	1.40	1.50	1.60	0.055	0.059	0.063
D1	1.40	1.50	1.60	0.055	0.059	0.063
P0	3.90	4.00	4.10	0.154	0.157	0.161
P1	7.90	8.00	8.10	0.311	0.315	0.319
P2	1.90	2.00	2.10	0.075	0.079	0.083
A0	6.85	6.90	7.00	0.270	0.271	0.276
B0	10.45	10.50	10.60	0.411	0.413	0.417
K0	2.68	2.78	2.88	0.105	0.109	0.113
T	0.24		0.27	0.009		0.011
t1	0.10			0.004		
10P0	39.80	40.00	40.20	1.567	1.575	1.583