

## General Description

The MY15P10D uses advanced trench technology and design to provide excellent RDS(ON) with low gate charge. It can be used in a wide variety of applications. It is ESD protested.

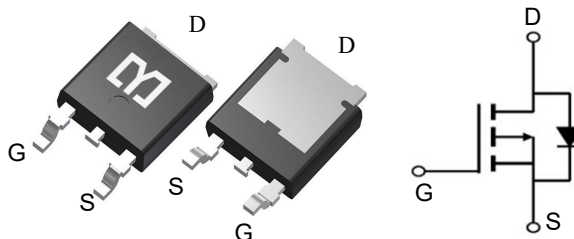


## Features

$V_{DSS}$	-100	V
$I_D$	-15	A
$P_D(T_C=25^\circ C)$	38	W
$R_{DS(ON)}(at V_{GS}=10V)$	<100	m $\Omega$

## Application

- Battery protection
- Load switch
- DC/DC converters



## Package Marking and Ordering Information

Product ID	Pack	Marking	Qty(PCS)
MY15P10D	TO-252-2L	MY15P10D	2500

## Absolute Maximum Ratings ( $T_C=25^\circ C$ unless otherwise noted)

Parameter	Symbol	Limit	Unit
Drain-Source Voltage	$V_{DS}$	-100	V
Gate-Source Voltage	$V_{GS}$	$\pm 20$	V
Drain Current-Continuous	$I_D$	-15	A
Drain Current-Continuous( $T_C=100^\circ C$ )	$I_D(100^\circ C)$	-13	A
Pulsed Drain Current	$I_{DM}$	-30	A
Maximum Power Dissipation	$P_D$	38	W
Derating factor		0.32	W/ $^\circ C$
Single pulse avalanche energy <sup>(Note 5)</sup>	$E_{AS}$	110	mJ
Operating Junction and Storage Temperature Range	$T_J, T_{STG}$	-55 To 150	$^\circ C$
Thermal Resistance, Junction-to-Case (Note 2)	$R_{\theta Jc}$	3.13	$^\circ C/W$

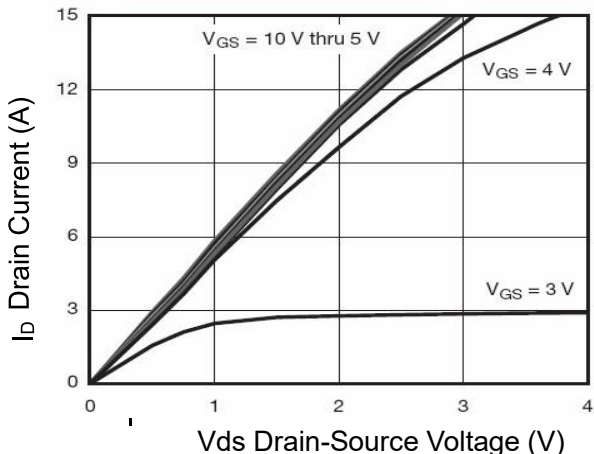
**Electrical Characteristics (T<sub>A</sub>=25 °C, unless otherwise noted)**

Parameter	Symbol	Condition	Min	Typ	Max	Unit
Drain-Source Breakdown Voltage	BV <sub>DSS</sub>	V <sub>GS</sub> =0V, I <sub>D</sub> =-250μA	-100	-	-	V
Zero Gate Voltage Drain Current	I <sub>DSS</sub>	V <sub>DS</sub> =-100V, V <sub>GS</sub> =0V	-	-	1	μA
Gate-Body Leakage Current	I <sub>GSS</sub>	V <sub>GS</sub> =±20V, V <sub>DS</sub> =0V	-	-	±10	μA
Gate Threshold Voltage	V <sub>GS(th)</sub>	V <sub>DS</sub> =V <sub>GS</sub> , I <sub>D</sub> =-250μA	-1	-	-3	V
Drain-Source On-State Resistance	R <sub>DS(ON)</sub>	V <sub>GS</sub> =-10V, I <sub>D</sub> =-16A	-	85	100	mΩ
Forward Transconductance	g <sub>FS</sub>	V <sub>DS</sub> =-15V, I <sub>D</sub> =-5A	12	-	-	S
Input Capacitance	C <sub>iss</sub>	V <sub>DS</sub> =-25V, V <sub>GS</sub> =0V, F=1.0MHz	-	760	-	PF
Output Capacitance	C <sub>oss</sub>		-	260	-	PF
Reverse Transfer Capacitance	C <sub>rss</sub>		-	170	-	PF
Turn-on Delay Time	t <sub>d(on)</sub>	V <sub>DD</sub> =-50V, I <sub>D</sub> =-10A V <sub>GS</sub> =-10V, R <sub>GEN</sub> =9.1	-	14	-	nS
Turn-on Rise Time	t <sub>r</sub>		-	18	-	nS
Turn-Off Delay Time	t <sub>d(off)</sub>		-	50	-	nS
Turn-Off Fall Time	t <sub>f</sub>		-	18	-	nS
Total Gate Charge	Q <sub>g</sub>	V <sub>DS</sub> =-50V, I <sub>D</sub> =-10A, V <sub>GS</sub> =-10V	-	25	-	nC
Gate-Source Charge	Q <sub>gs</sub>		-	5	-	nC
Gate-Drain Charge	Q <sub>gd</sub>		-	7	-	nC
Diode Forward Voltage (Note 3)	V <sub>SD</sub>	V <sub>GS</sub> =0V, I <sub>S</sub> =-10A	-	-	-1.2	V
Diode Forward Current (Note 2)	I <sub>S</sub>	-	-	-	-13	A
Reverse Recovery Time	t <sub>rr</sub>	T <sub>J</sub> = 25°C, I <sub>F</sub> = -10A di/dt = 100A/μs (Note 3)	-	35	-	nS
Reverse Recovery Charge	Q <sub>rr</sub>		-	46	-	nC
Forward Turn-On Time	t <sub>on</sub>	Intrinsic turn-on time is negligible (turn-on is dominated by LS+LD)				

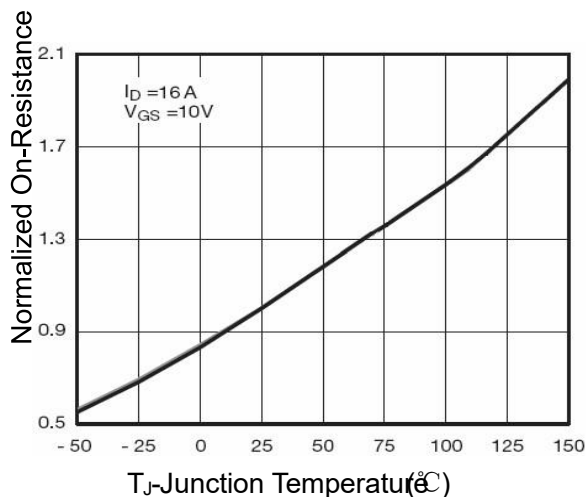
**Notes:**

1. Repetitive Rating: Pulse width limited by maximum junction temperature.
2. Surface Mounted on FR4 Board, t ≤ 10 sec.
3. Pulse Test: Pulse Width ≤ 300μs, Duty Cycle ≤ 2%.
4. Guaranteed by design, not subject to production
5. EAS condition: T<sub>J</sub>=25°C, V<sub>DD</sub>=-50V, V<sub>G</sub>=-10V, L=0.5mH, R<sub>g</sub>=25

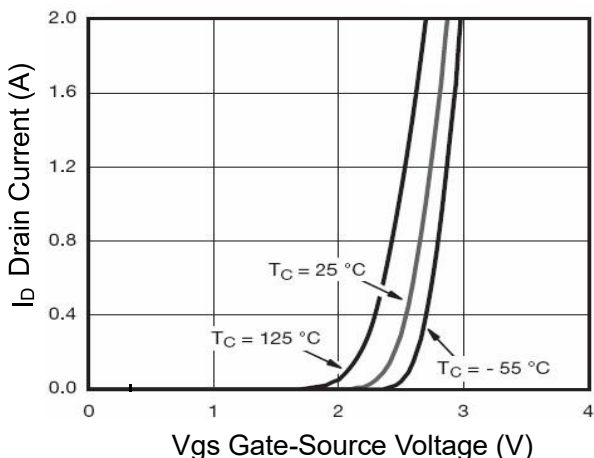
**Typical Characteristics**



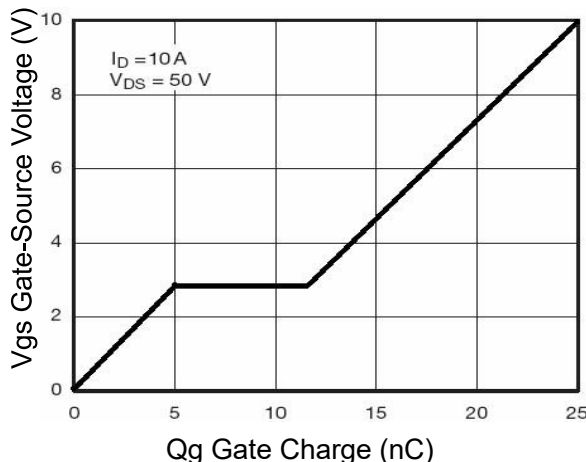
**Figure 1 Output Characteristics**



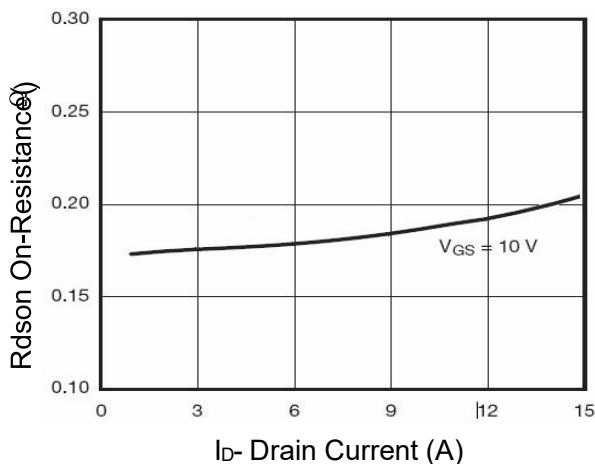
**Figure 4 Rdson-Junction Temperature**



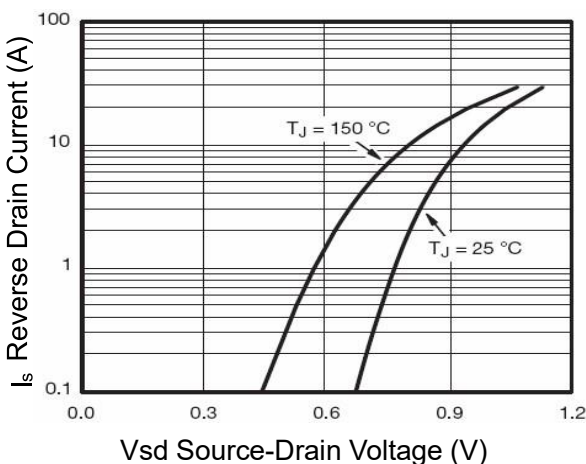
**Figure 2 Transfer Characteristics**



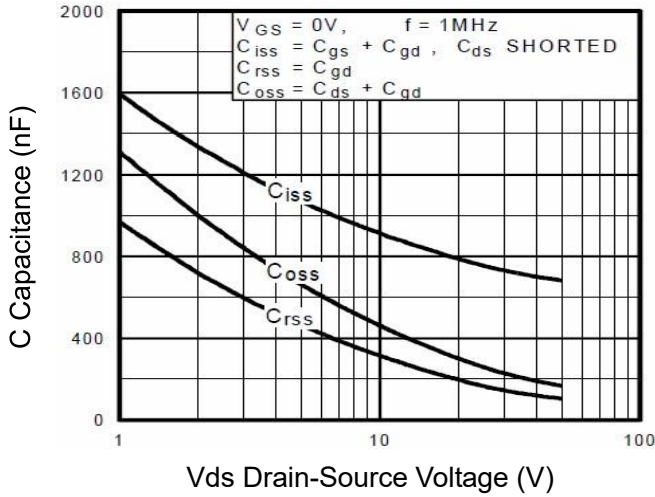
**Figure 5 Gate Charge**



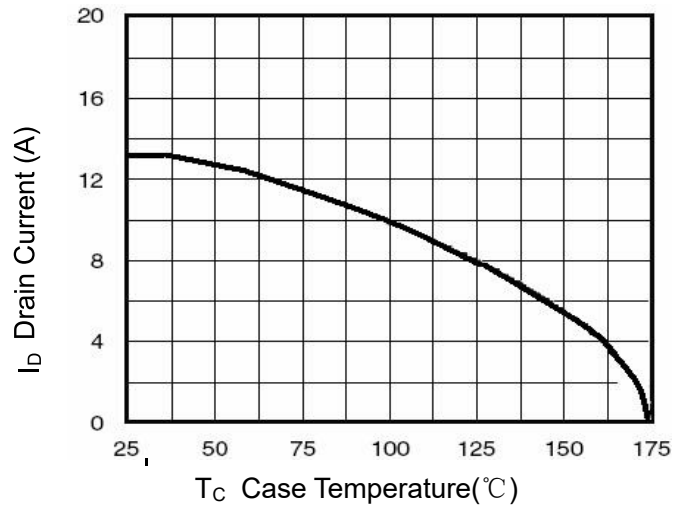
**Figure 3 Rdson Drain Current**



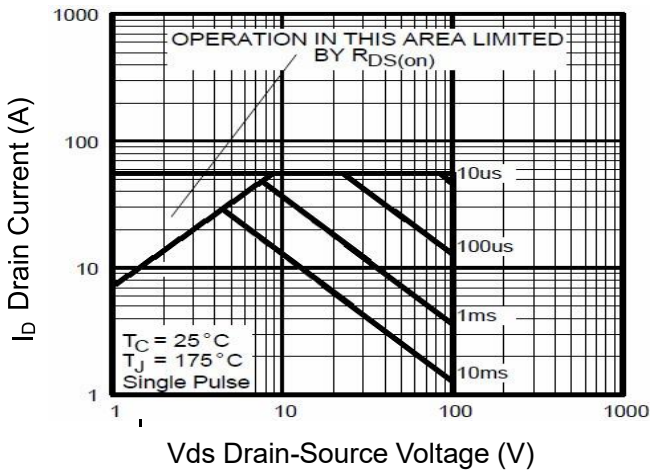
**Figure 6 Source-Drain Diode Forward**



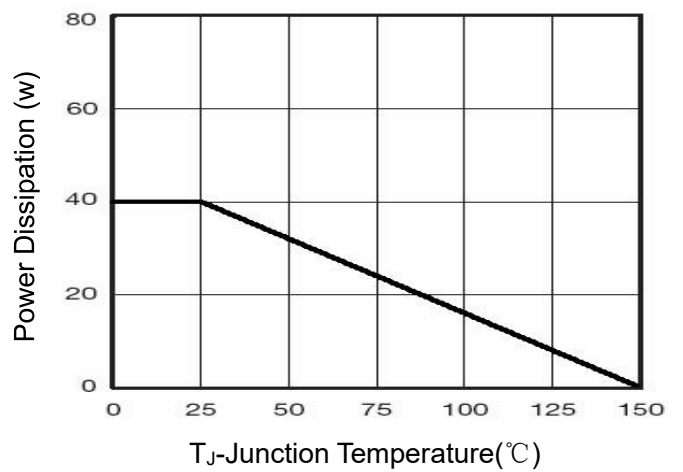
**Figure 7 Capacitance vs Vds**



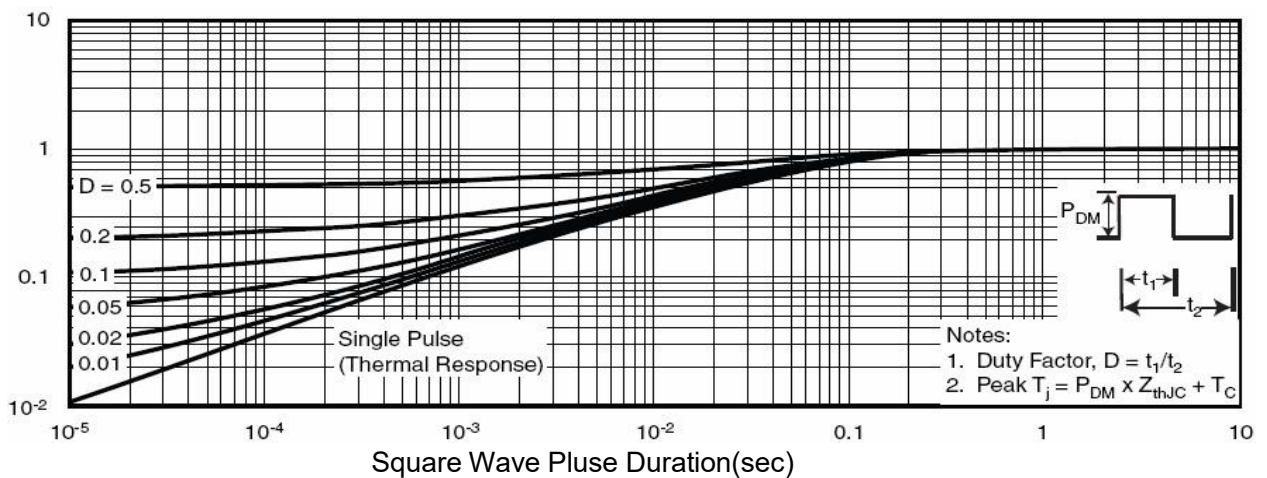
**Figure 9 Drain Current vs Case Temperature**



**Figure 8 Safe Operation Area**

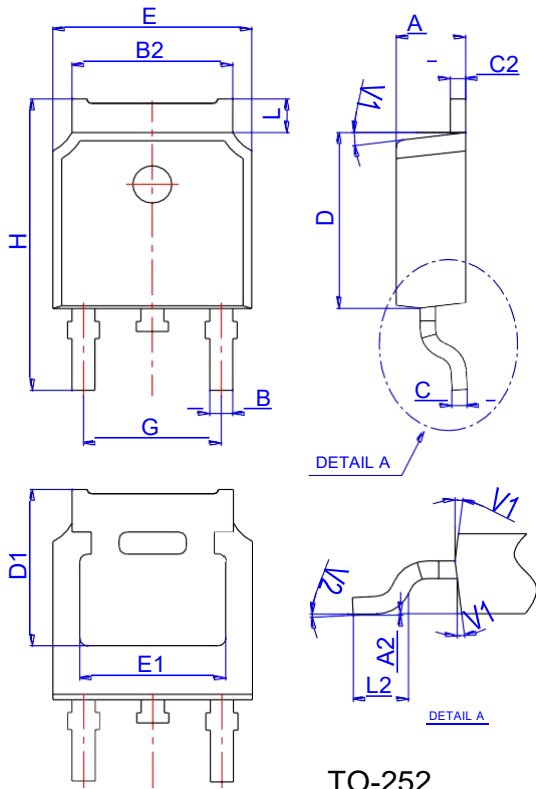


**Figure 10 Power De-rating**



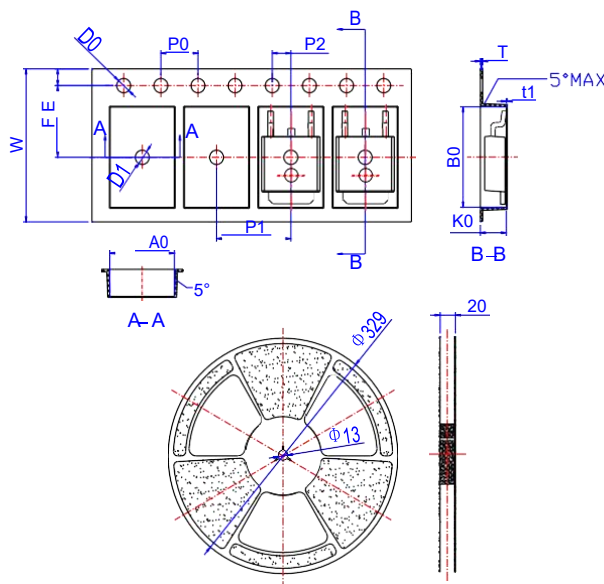
**Figure 11 Normalized Maximum Transient Thermal**

**Package Mechanical Data-TO-252-JQ Single**



Ref.	Dimensions					
	Millimeters			Inches		
	Min.	Typ.	Max.	Min.	Typ.	Max.
A	2.10		2.50	0.083		0.098
A2	0		0.10	0		0.004
B	0.66		0.86	0.026		0.034
B2	5.18		5.48	0.202		0.216
C	0.40		0.60	0.016		0.024
C2	0.44		0.58	0.017		0.023
D	5.90		6.30	0.232		0.248
D1	5.30REF			0.209REF		
E	6.40		6.80	0.252		0.268
E1	4.63			0.182		
G	4.47		4.67	0.176		0.184
H	9.50		10.70	0.374		0.421
L	1.09		1.21	0.043		0.048
L2	1.35		1.65	0.053		0.065
V1		7°			7°	
V2	0°		6°	0°		6°

**Reel Specification-TO-252**



Ref.	Dimensions					
	Millimeters			Inches		
	Min.	Typ.	Max.	Min.	Typ.	Max.
W	15.90	16.00	16.10	0.626	0.630	0.634
E	1.65	1.75	1.85	0.065	0.069	0.073
F	7.40	7.50	7.60	0.291	0.295	0.299
D0	1.40	1.50	1.60	0.055	0.059	0.063
D1	1.40	1.50	1.60	0.055	0.059	0.063
P0	3.90	4.00	4.10	0.154	0.157	0.161
P1	7.90	8.00	8.10	0.311	0.315	0.319
P2	1.90	2.00	2.10	0.075	0.079	0.083
A0	6.85	6.90	7.00	0.270	0.271	0.276
B0	10.45	10.50	10.60	0.411	0.413	0.417
K0	2.68	2.78	2.88	0.105	0.109	0.113
T	0.24		0.27	0.009		0.011
t1	0.10			0.004		
10P0	39.80	40.00	40.20	1.567	1.575	1.583