

General Description

The MY10P06D uses advanced trench technology to provide excellent $R_{DS(ON)}$, low gate charge and operation with gate voltages as low as 4.5V.

This device is suitable for use as a Battery protection or in other Switching application.



Features

V_{DSS}	-60	V
I_D	-10	A
$R_{DS(ON)}$ (at $V_{GS} = -10V$)	80	$m\Omega$
$R_{DS(ON)}$ (at $V_{GS} = -4.5V$)	95	$m\Omega$

Application

- Battery protection
- Load switch
- Uninterruptible power supply

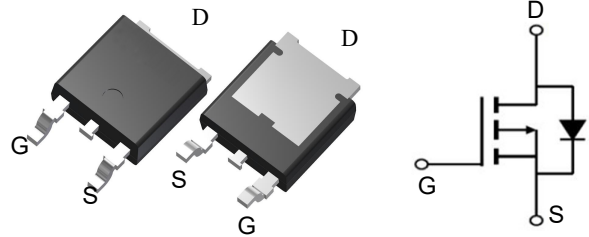

Package Marking and Ordering Information

Product ID	Pack	Marking	Qty(PCS)
MY10P06D	TO-252-2L	MY10P06D	2500

Absolute Maximum Ratings ($T_A = 25\text{ }^\circ\text{C}$ unless otherwise noted)

Symbol	Parameter	Rating	Units
V_{DS}	Drain-Source Voltage	-60	V
V_{GS}	Gate-Source Voltage	± 20	V
$I_{D@T_C=25C}$	Continuous Drain Current, $V_{GS} @ -10V^1$	-10	A
$I_{D@T_C=100C}$	Continuous Drain Current, $V_{GS} @ -10V^1$	-8	A
$I_{D@T_A=25C}$	Continuous Drain Current, $V_{GS} @ -10V^1$	-9	A
$I_{D@T_A=70C}$	Continuous Drain Current, $V_{GS} @ -10V^1$	-6.5	A
I_{DM}	Pulsed Drain Current ²	-36	A
EAS	Single Pulse Avalanche Energy ³	25	mJ
I_{AS}	Avalanche Current	-26.6	A
$P_D@T_C=25C$	Total Power Dissipation ⁴	3.0	W
$P_D@T_A=25C$	Total Power Dissipation ⁴	2	W
T_{STG}	Storage Temperature Range	-55 to 150	$^\circ\text{C}$
T_J	Operating Junction Temperature Range	-55 to 150	$^\circ\text{C}$
$R_{\theta JA}$	Thermal Resistance Junction-Ambient ¹	42	$^\circ\text{C/W}$
$R_{\theta JC}$	Thermal Resistance Junction-Case ¹	3.6	$^\circ\text{C/W}$

Electrical Characteristics (T_A=25 °C, unless otherwise noted)

Symbol	Parameter	Conditions	Min.	Typ.	Max.	Unit
BV _{DSS}	Drain-Source Breakdown Voltage	V _{GS} =0V, I _D =-250uA	-60	---	---	V
ΔBV _{DSS} / ΔT _J	BV _{DSS} Temperature Coefficient	Reference to 25C, I _D =-1mA	---	-0.003	---	V/ °C
R _{DS(ON)}	Static Drain-Source On-Resistance	V _{GS} =-10V, I _D =-8A	---	80	110	mΩ
		V _{GS} =-4.5V, I _D =-5A	---	95	157	
V _{GS(th)}	Gate Threshold Voltage		-1.2	1.5	-2.5	V
ΔV _{GS(th)}	V _{GS(th)} Temperature Coefficient	V _{GS} =V _{DS} , I _D =-250uA	---	4.56	---	mV/ °C
I _{DSS}	Drain-Source Leakage Current	V _{DS} =-48V, V _{GS} =0V, T _J =25C	---	---	-1	uA
		V _{DS} =-48V, V _{GS} =0V, T _J =55C	---	---	-5	
I _{GSS}	Gate-Source Leakage Current	V _{GS} =±20V, V _{DS} =0V	---	---	±100	nA
g _{fs}	Forward Transconductance	V _{DS} =-5V, I _D =-12A	---	15.4	---	S
R _g	Gate Resistance	V _{DS} =0V, V _{GS} =0V, f=1MHz	---	13.5	---	Ω
Q _g	Total Gate Charge (-4.5V)	V _{DS} =-48V, V _{GS} =-4.5V, I _D =-10A	---	9.86	---	nC
Q _{gs}	Gate-Source Charge		---	3.08	---	
Q _{gd}	Gate-Drain Charge		---	2.95	---	
T _{d(on)}	Turn-On Delay Time	V _{DD} =-15V, V _{GS} =-10V, R _G =3.3□, I _D =-1A	---	28.8	---	ns
T _r	Rise Time		---	19.8	---	
T _{d(off)}	Turn-Off Delay Time		---	60.8	---	
T _f	Fall Time		---	7.2	---	
C _{iss}	Input Capacitance	V _{DS} =-15V, V _{GS} =0V, f=1MHz	---	800	---	pF
C _{oss}	Output Capacitance		---	97.3	---	
C _{rss}	Reverse Transfer Capacitance		---	70	---	
I _S	Continuous Source Current ^{1,5}	V _G =V _D =0V, Force Current	---	---	-18	A
I _{SM}	Pulsed Source Current ^{2,5}		---	---	-36	A
V _{SD}	Diode Forward Voltage ²	V _{GS} =0V, I _S =-1A, T _J =25C	---	---	-1.2	V

Note :

- 1.The data tested by surface mounted on a 1 inch² FR-4 board with 2OZ copper.
- 2.The data tested by pulsed, pulse width ≤ 300us, duty cycle ≤ 2%
- 3.The EAS data shows Max. rating. The test condition is V_{DD}=-25V, V_{GS}=-10V, L=0. 1mH, I_{AS}=-26.6A
- 4.The power dissipation is limited by 150C junction temperature
- 5.The data is theoretically the same as I_D and I_{DM}, in real applications, should be limited by total power dissipation.

Typical Characteristics

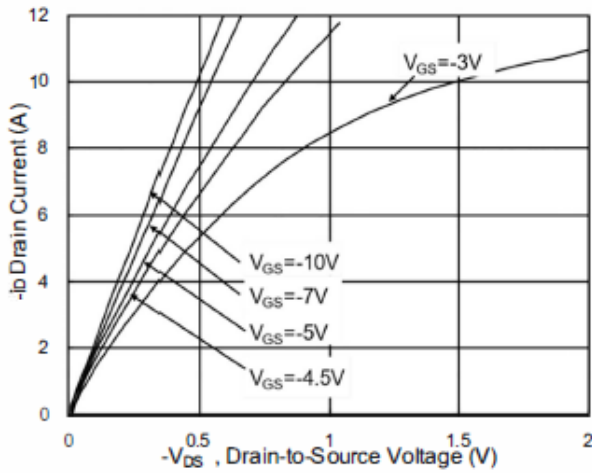

Fig.1 Typical Output Characteristics

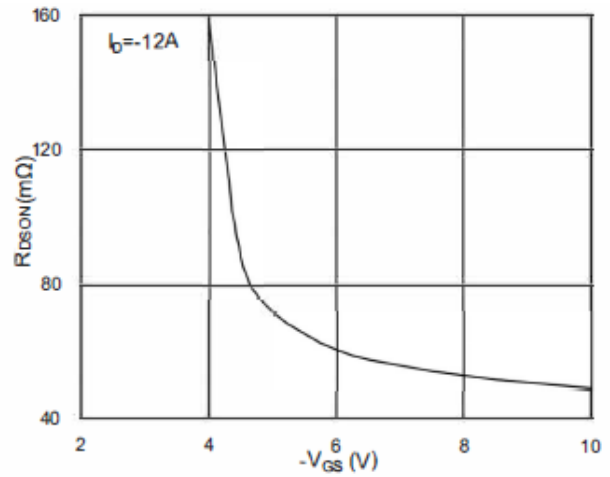

Fig.2 On-Resistance v.s Gate-Source

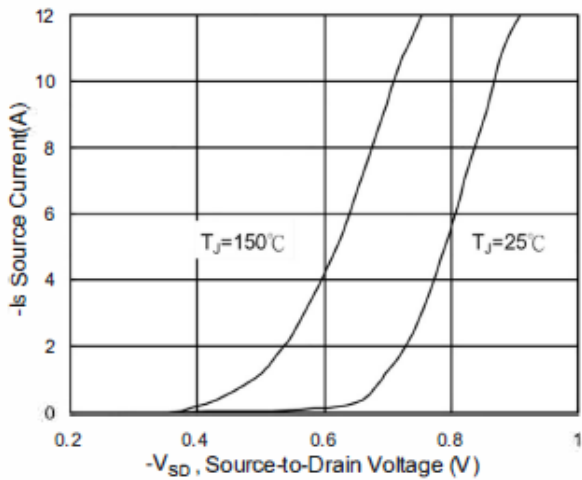

Fig.3 Forward Characteristics of Reverse

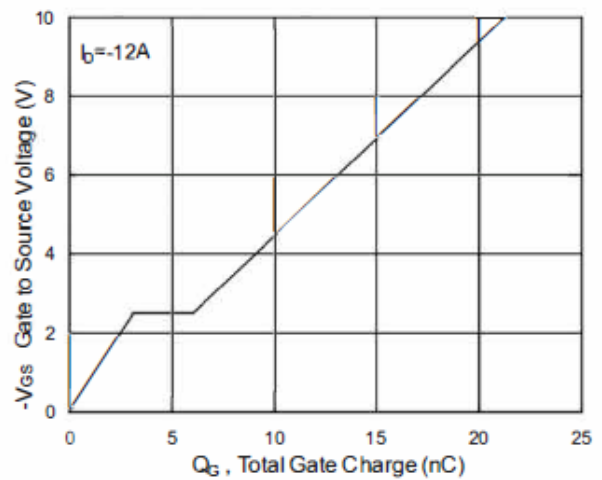

Fig.4 Gate-Charge Characteristics

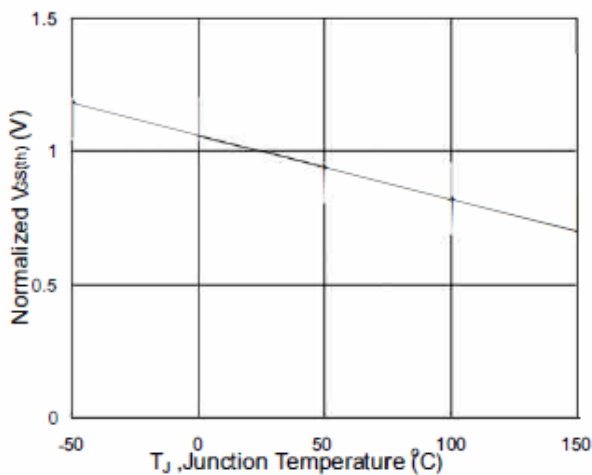

Fig.5 Normalized $V_{GS(th)}$ v.s T_J

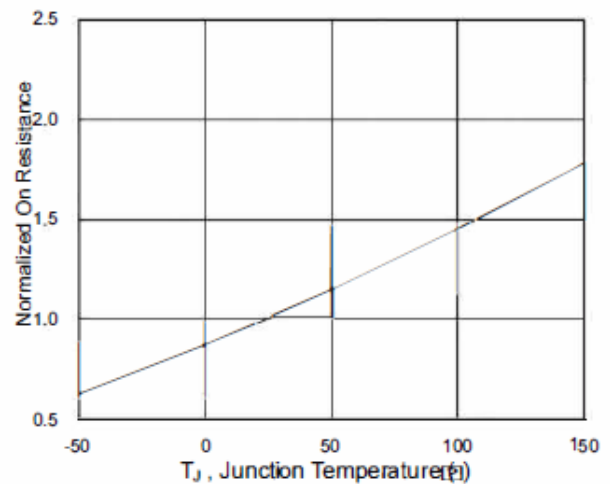

Fig.6 Normalized $R_{DS(on)}$ v.s T_J

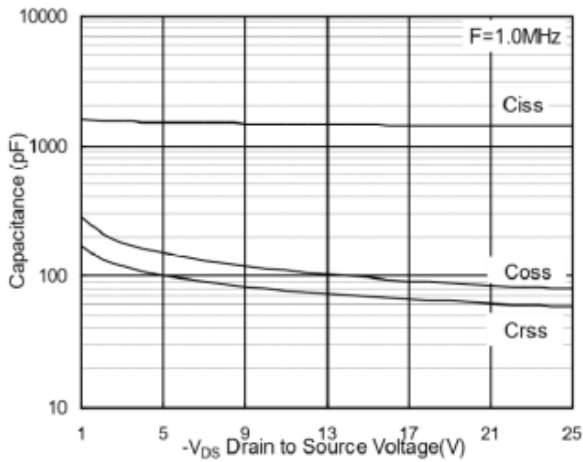

Fig.7 Capacitance

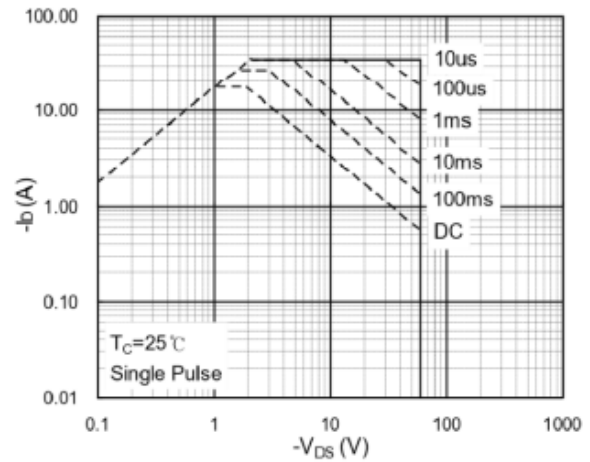

Fig.8 Safe Operating Area

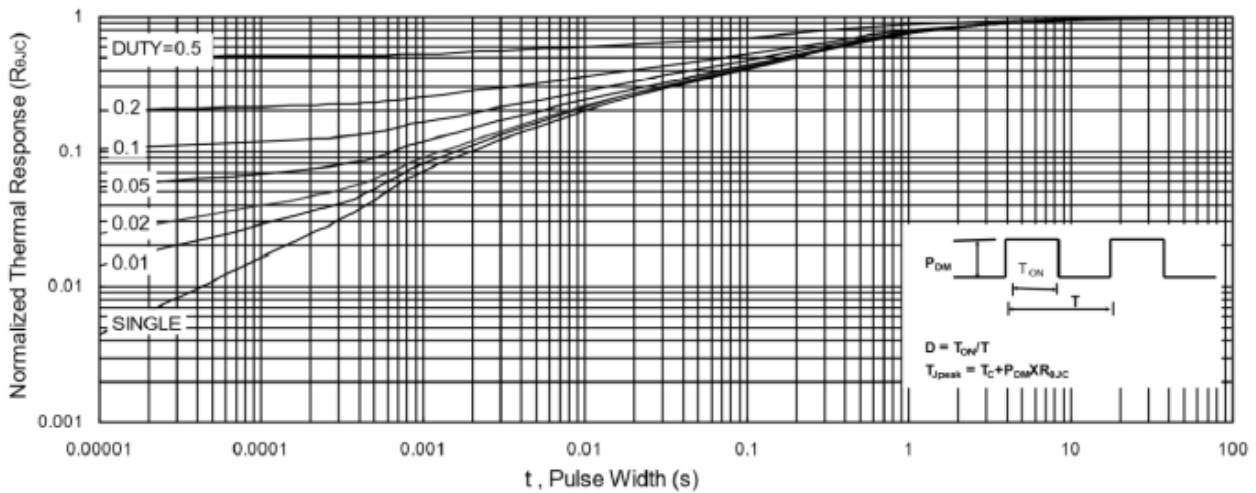

Fig.9 Normalized Maximum Transient Thermal Impedance

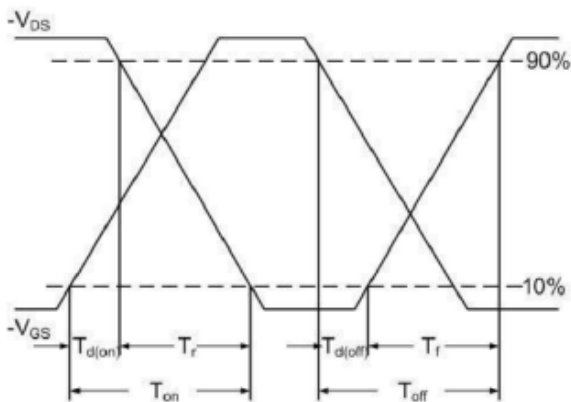

Fig.10 Switching Time Waveform

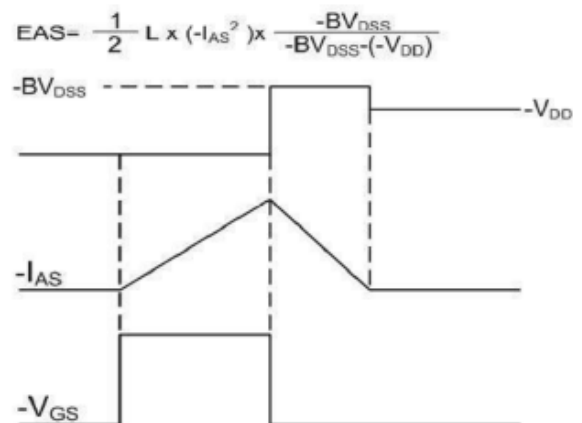
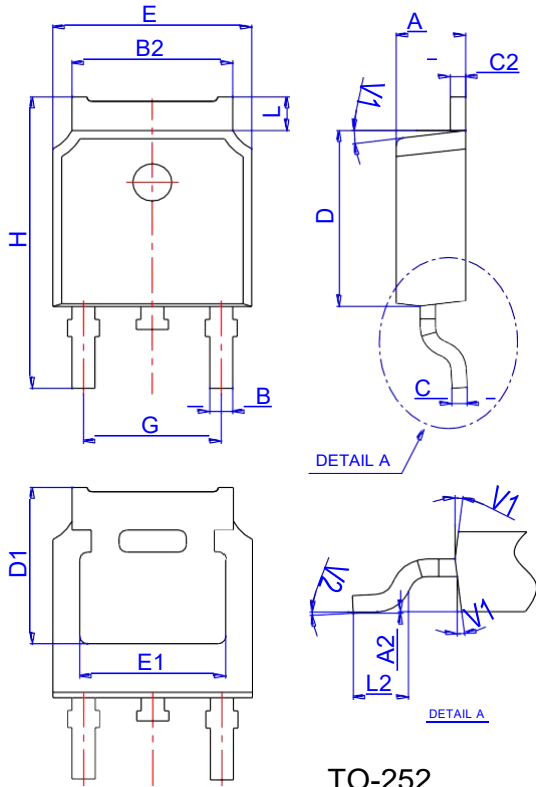

Fig.11 Unclamped Inductive Waveform

Package Mechanical Data-TO-252-JQ Single



Ref.	Dimensions					
	Millimeters			Inches		
	Min.	Typ.	Max.	Min.	Typ.	Max.
A	2.10		2.50	0.083		0.098
A2	0		0.10	0		0.004
B	0.66		0.86	0.026		0.034
B2	5.18		5.48	0.202		0.216
C	0.40		0.60	0.016		0.024
C2	0.44		0.58	0.017		0.023
D	5.90		6.30	0.232		0.248
D1	5.30REF			0.209REF		
E	6.40		6.80	0.252		0.268
E1	4.63			0.182		
G	4.47		4.67	0.176		0.184
H	9.50		10.70	0.374		0.421
L	1.09		1.21	0.043		0.048
L2	1.35		1.65	0.053		0.065
V1		7°			7°	
V2	0°		6°	0°		6°

Reel Specification-TO-252

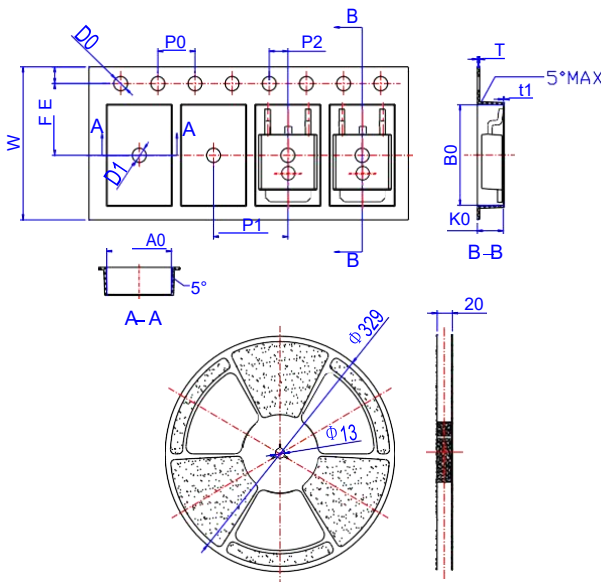

Ref.	Dimensions					
	Millimeters			Inches		
	Min.	Typ.	Max.	Min.	Typ.	Max.
W	15.90	16.00	16.10	0.626	0.630	0.634
E	1.65	1.75	1.85	0.065	0.069	0.073
F	7.40	7.50	7.60	0.291	0.295	0.299
D0	1.40	1.50	1.60	0.055	0.059	0.063
D1	1.40	1.50	1.60	0.055	0.059	0.063
P0	3.90	4.00	4.10	0.154	0.157	0.161
P1	7.90	8.00	8.10	0.311	0.315	0.319
P2	1.90	2.00	2.10	0.075	0.079	0.083
A0	6.85	6.90	7.00	0.270	0.271	0.276
B0	10.45	10.50	10.60	0.411	0.413	0.417
K0	2.68	2.78	2.88	0.105	0.109	0.113
T	0.24		0.27	0.009		0.011
t1	0.10			0.004		
10P0	39.80	40.00	40.20	1.567	1.575	1.583