

General Description

The MY013FNE3 uses advanced trench technology to provide excellent $R_{DS(ON)}$, low gate charge and operation with gate voltages as low as 4.5V This device is suitable for use as a Battery protection or in other Switching application.



Features

V_{DSS}	60	V
I_D	50	A
$R_{DS(ON)}$ (at $V_{GS}=10V$)	<13	$m\Omega$
$R_{DS(ON)}$ (at $V_{GS}=4.5V$)	<15	$m\Omega$

Application

- Battery protection
- Load switch
- Uninterruptible power supply

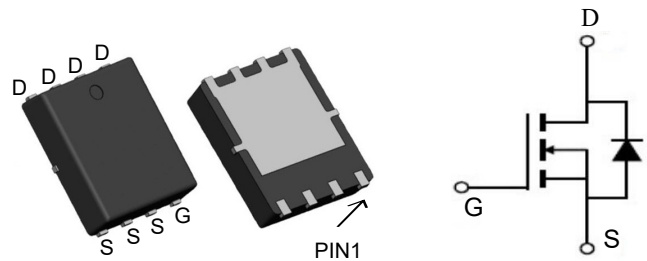

Package Marking and Ordering Information

Product ID	Pack	Marking	Qty(PCS)
MY013FNE3	PDFN3*3-8	013FN	5000

Absolute Maximum Ratings ($T_C=25^\circ C$ unless otherwise noted)

Symbol	Parameter	Rating	Units
V_{DS}	Drain-Source Voltage	60	V
V_{GS}	Gate-Source Voltage	± 20	V
$I_D@T_C=25^\circ C$	Continuous Drain Current, $V_{GS} @ 10V^1$	50	A
$I_D@T_C=100^\circ C$	Continuous Drain Current, $V_{GS} @ 10V^1$	31	A
I_{DM}	Pulsed Drain Current ²	120	A
EAS	Single Pulse Avalanche Energy ³	80	mJ
I_{AS}	Avalanche Current	40	A
$P_D@T_C=25^\circ C$	Total Power Dissipation ⁴	41	W
T_{STG}	Storage Temperature Range	-55 to 150	$^\circ C$
T_J	Operating Junction Temperature Range	-55 to 150	$^\circ C$
$R_{\theta JA}$	Thermal Resistance Junction-ambient ¹ ($t \leq 10S$)	35	$^\circ C/W$
	Thermal Resistance Junction-ambient ¹ (Steady State)	55	$^\circ C/W$
$R_{\theta JC}$	Thermal Resistance Junction-case ¹	3	$^\circ C/W$

Electrical Characteristics (T_J=25 °C, unless otherwise noted)

Symbol	Parameter	Conditions	Min.	Typ.	Max.	Unit
BV _{DSS}	Drain-Source Breakdown Voltage	V _{GS} =0V, I _D =250uA	60	---	---	V
R _{DS(on)}	Static Drain-Source On-Resistance ²	V _{GS} =10V, I _D =20A	---	10	13	mΩ
		V _{GS} =4.5V, I _D =15A	---	12	15	mΩ
V _{GS(th)}	Gate Threshold Voltage	V _{GS} =V _{DS} , I _D =250uA	1.2	---	2.5	V
I _{DSS}	Drain-Source Leakage Current	V _{DS} =48V, V _{GS} =0V, T _J =25 °C	---	---	1	uA
		V _{DS} =48V, V _{GS} =0V, T _J =55 °C	---	---	5	
I _{GSS}	Gate-Source Leakage Current	V _{GS} =±20V, V _{DS} =0V	---	---	±100	nA
R _g	Gate Resistance	V _{DS} =0V, V _{GS} =0V, f=1MHz	---	1.2	---	Ω
Q _g	Total Gate Charge (10V)	V _{DS} =30V, V _{GS} =10V, I _D =18A	---	57	---	nC
Q _{gs}	Gate-Source Charge		---	8.7	---	
Q _{gd}	Gate-Drain Charge		---	14	---	
T _{d(on)}	Turn-On Delay Time	V _{DD} =30V, V _{GS} =10V, R _G =3.3 I _D =20A	---	16.2	---	ns
T _r	Rise Time		---	41.2	---	
T _{d(off)}	Turn-Off Delay Time		---	56.4	---	
T _f	Fall Time		---	16.2	---	
C _{iss}	Input Capacitance	V _{DS} =30V, V _{GS} =0V, f=1MHz	---	1260	---	pF
C _{oss}	Output Capacitance		---	139	---	
C _{rss}	Reverse Transfer Capacitance		---	87	---	
I _s	Continuous Source Current ^{1,5}	V _G =V _D =0V, Force Current	---	---	50	A
V _{SD}	Diode Forward Voltage ²	V _{GS} =0V, I _s =1A, T _J =25 °C	---	---	1.2	V
t _{rr}	Reverse Recovery Time	I _F =20A, dI/dt=100A/μs, T _J =25 °C	---	22	---	nS
Q _{rr}	Reverse Recovery Charge		---	72	---	nC

Note :

- 1.The data tested by surface mounted on a 1 inch² FR-4 board with 2OZ copper.
- 2.The data tested by pulsed, pulse width ≤ 300us, duty cycle ≤ 2%
- 3.The EAS data shows Max. rating. The test condition is V_{DD}=50V, V_{GS}=10V, L=0.1mH, I_{AS}=40A
- 4.The power dissipation is limited by 150 °C junction temperature
- 5.The data is theoretically the same as I_D and I_{DM}, in real applications, should be limited by total power dissipation.

Typical Characteristics

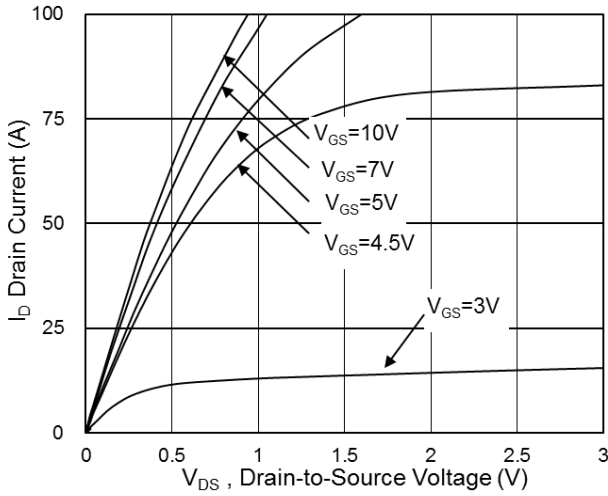

Fig.1 Typical Output Characteristics

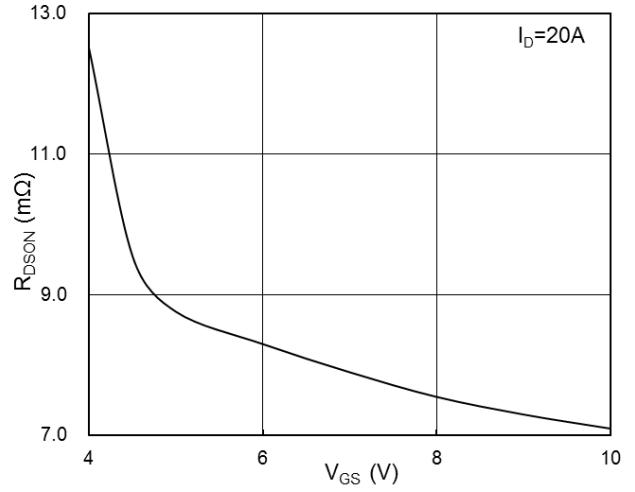

Fig.2 On-Resistance v.s Gate-Source

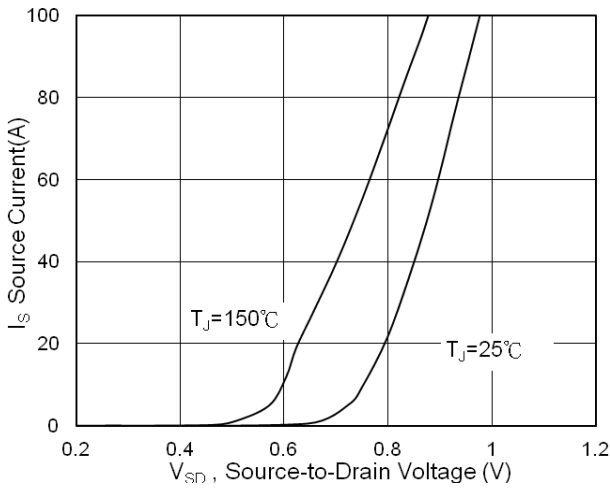

Fig.3 Forward Characteristics of Reverse

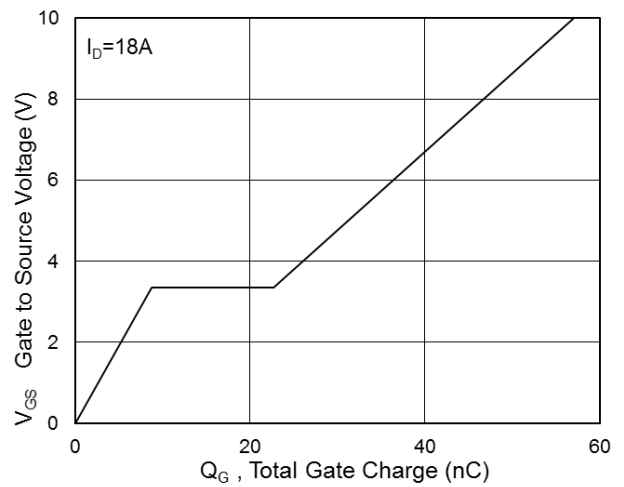

Fig.4 Gate-Charge Characteristics

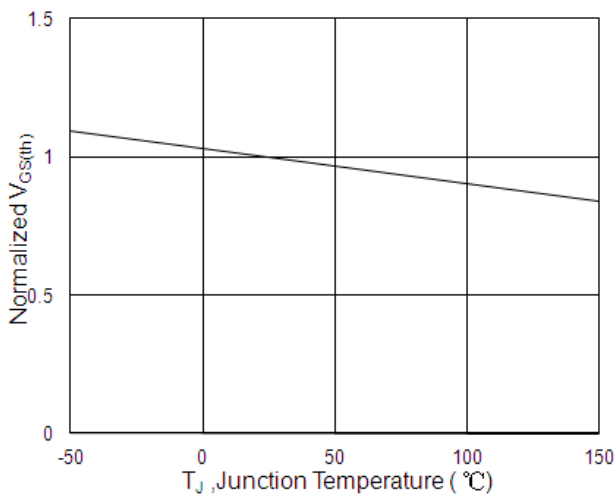

Fig.5 Normalized $V_{GS(th)}$ vs. T_J

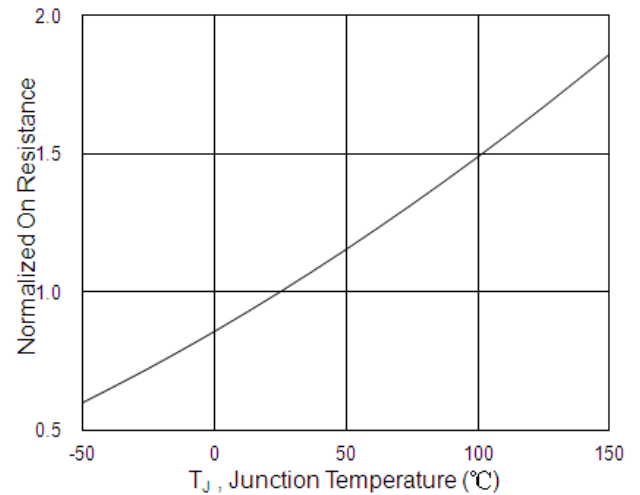

Fig.6 Normalized R_{DSON} vs. T_J

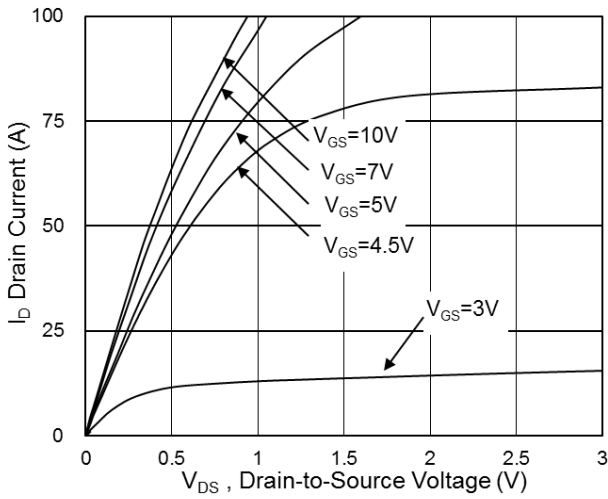

Fig.1 Typical Output Characteristics

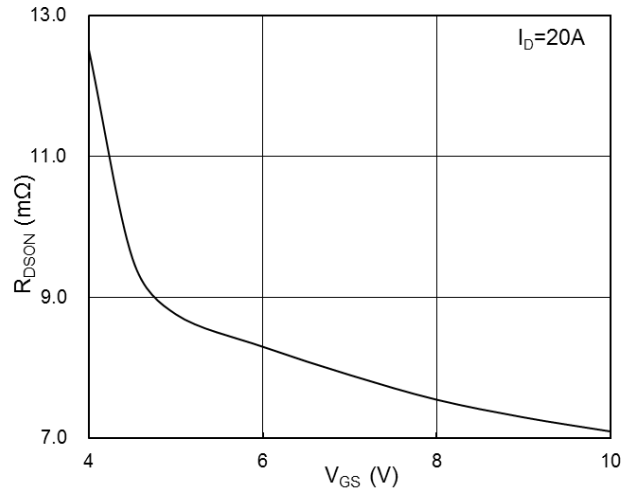

Fig.2 On-Resistance v.s Gate-Source

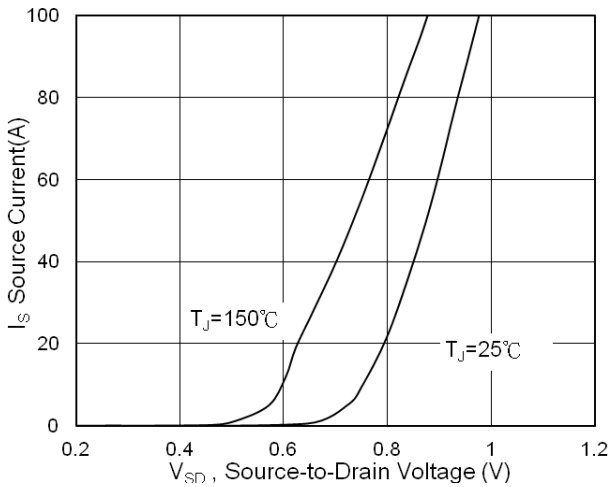

Fig.3 Forward Characteristics of Reverse

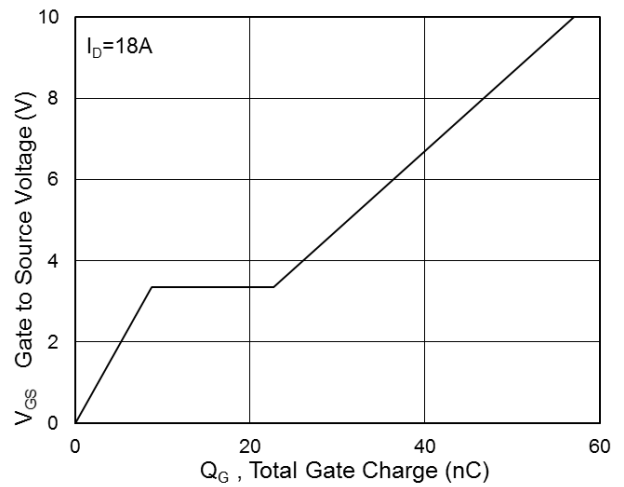

Fig.4 Gate-Charge Characteristics

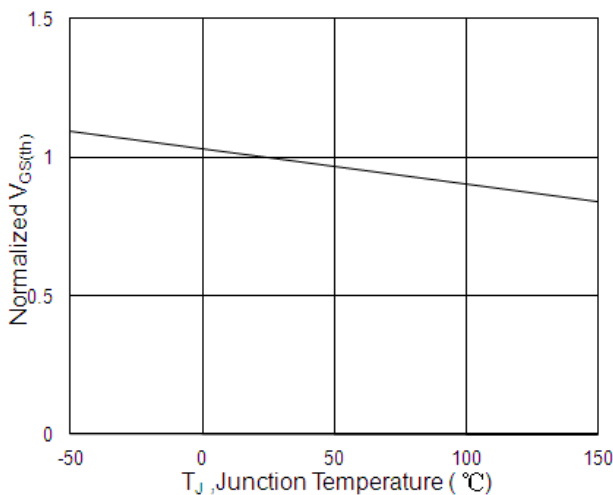

Fig.5 Normalized $V_{GS(th)}$ vs. T_J

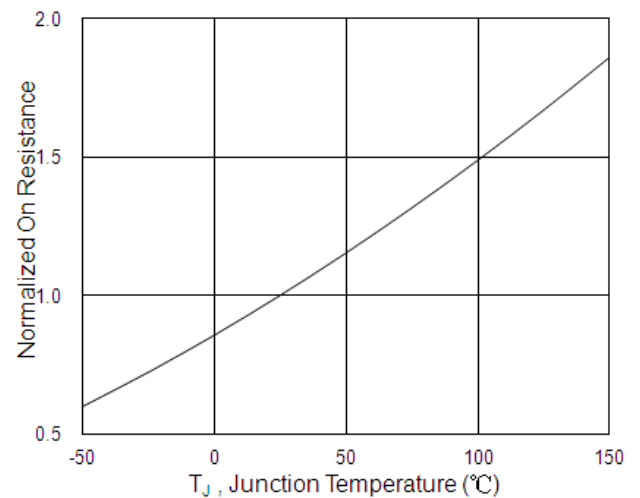
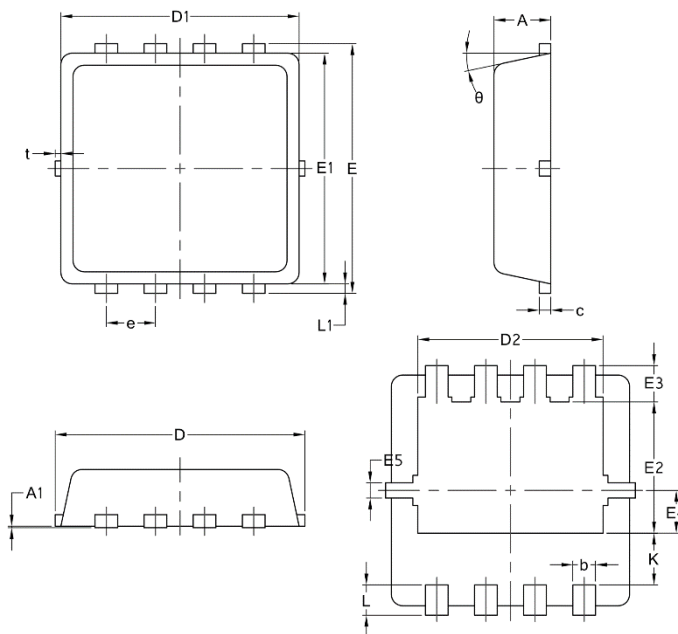

Fig.6 Normalized $R_{DS(on)}$ vs. T_J

Package Mechanical Data-DFN3*3-8L-JQ Single



Symbol	Common		
	mm		
	Mim	Nom	Max
A	0.70	0.75	0.85
A1	/	/	0.05
b	0.20	0.30	0.40
c	0.10	0.152	0.25
D	3.15	3.30	3.45
D1	3.00	3.15	3.25
D2	2.29	2.45	2.65
E	3.15	3.30	3.45
E1	2.90	3.05	3.20
E2	1.54	1.74	1.94
E3	0.28	0.48	0.65
E4	0.37	0.57	0.77
E5	0.10	0.20	0.30
e	0.60	0.65	0.70
K	0.59	0.69	0.89
L	0.30	0.40	0.50
L1	0.06	0.125	0.20
t	0	0.075	0.13
Φ	10	12	14