

### General Description

The AP80P06NF uses advanced trench technology to provide excellent  $R_{DS(ON)}$ , low gate charge and operation with gate voltages as low as 4.5V. This device is suitable for use as a load switch or in PWM applications.

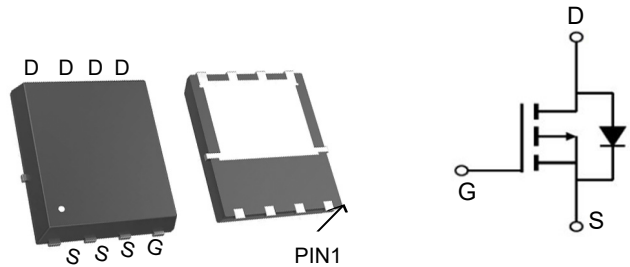


### Features

$V_{DS}$	-60	X
$V_{GS}$	-80	C
$T_{FUT}$	13	o á
$T_{FUT}$	16	o á

### Application

- PWM applications
- Load switch
- Power management



### Package Marking and Ordering Information

Product ID	Pack	Marking	Qty(PCS)
AP80P06NF	PDFN5*6-8L	80P06	5000

### Absolute Maximum Ratings ( $T_A=25^\circ\text{C}$ unless otherwise noted)

Parameter	Symbol	Limit	Unit
Drain-Source Voltage	$V_{DS}$	-60	V
Gate-Source Voltage	$V_{GS}$	$\pm 20$	V
Drain Current-Continuous@ Current-Pulsed (Note 1)	$I_D(25^\circ\text{C})$	-80	A
	$I_D(70^\circ\text{C})$	-50	A
	$I_{DM}$	-85	A
Maximum Power Dissipation	$P_D$	60	W
Operating Junction and Storage Temperature Range	$T_J, T_{STG}$	-55 To 175	$^\circ\text{C}$
Thermal Resistance, Junction-to-Ambient (Note 2)	$R_{\theta JA}$	25	$^\circ\text{C/W}$

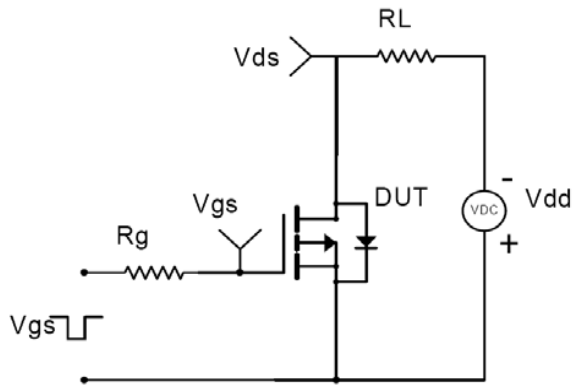
**Electrical Characteristics (T<sub>A</sub>=25 °C, unless otherwise noted)**

Parameter	Symbol	Condition	Min	Typ	Max	Unit
Drain-Source Breakdown Voltage	BV <sub>DSS</sub>	V <sub>GS</sub> =0V, I <sub>D</sub> =-250μA	-60			V
Zero Gate Voltage Drain Current	I <sub>DSS</sub>	V <sub>DS</sub> =-48V, V <sub>GS</sub> =0V			-1	μA
Gate-Body Leakage Current	I <sub>GSS</sub>	V <sub>GS</sub> =±20V, V <sub>DS</sub> =0V			±100	nA
Gate Threshold Voltage	V <sub>GS(th)</sub>	V <sub>DS</sub> =V <sub>GS</sub> , I <sub>D</sub> =-250μA	-1	-1.8	-2.5	V
Drain-Source On-State Resistance	R <sub>DS(ON)</sub>	V <sub>GS</sub> =-10V, I <sub>D</sub> =-20A		13	17	mΩ
		V <sub>GS</sub> =-4.5V, I <sub>D</sub> =-20A		16	20	mΩ
Forward Transconductance	g <sub>FS</sub>	V <sub>DS</sub> =-5V, I <sub>D</sub> =-20A	5			S
Input Capacitance	C <sub>iss</sub>	V <sub>DS</sub> =-30V, V <sub>GS</sub> =0V, F=1.0MHz		4130		PF
Output Capacitance	C <sub>oss</sub>			420		PF
Reverse Transfer Capacitance	C <sub>rss</sub>			145		PF
Turn-on Delay Time	t <sub>d(on)</sub>	V <sub>DS</sub> =-30V, V <sub>GS</sub> =-10V, R <sub>GEN</sub> =3Ω I <sub>D</sub> =1A		14		nS
Turn-on Rise Time	t <sub>r</sub>			20		nS
Turn-Off Delay Time	t <sub>d(off)</sub>			40		nS
Turn-Off Fall Time	t <sub>f</sub>			19		nS
Total Gate Charge	Q <sub>g</sub>	V <sub>DS</sub> =-30V, I <sub>D</sub> =-20A, V <sub>GS</sub> =-10V		48		nC
Gate-Source Charge	Q <sub>gs</sub>			11		nC
Gate-Drain Charge	Q <sub>gd</sub>			10		nC
Body Diode Reverse Recovery Time	T <sub>rr</sub>	I <sub>F</sub> =-20A, dI/dt=100A/μs		40		nS
Body Diode Reverse Recovery Charge	Q <sub>rr</sub>			56		nC
Diode Forward Voltage (Note 3)	V <sub>SD</sub>	V <sub>GS</sub> =0V, I <sub>S</sub> =-1A		-0.72	-1	V

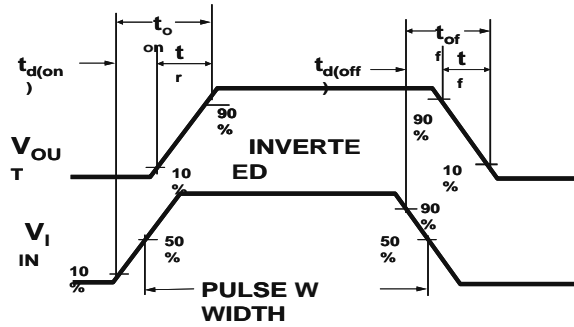
**NOTES:**

1. Repetitive Rating: Pulse width limited by maximum junction temperature.
2. Surface Mounted on 1in<sup>2</sup> FR4 Board, t ≤ 10 sec.
3. Pulse Test: Pulse Width ≤ 300μs, Duty Cycle ≤ 2%.
4. Guaranteed by design, not subject to production testing.

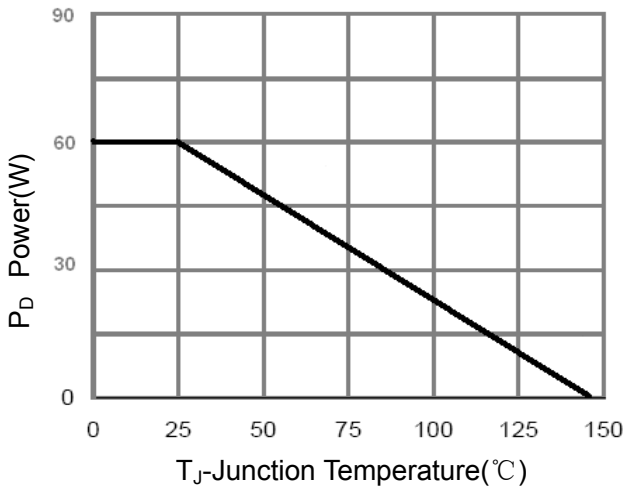
**Typical Characteristics**



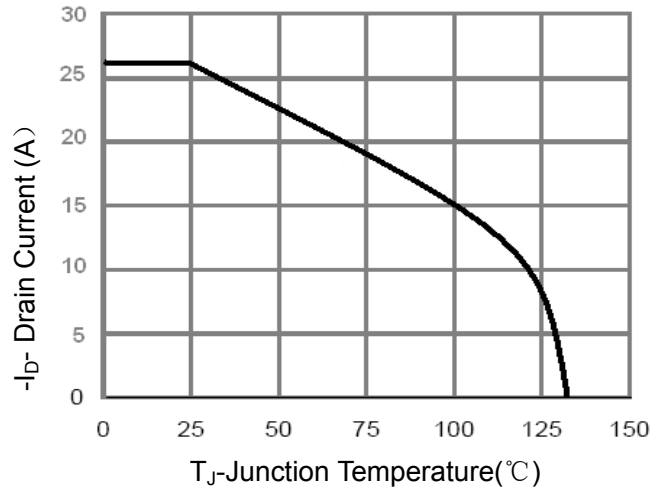
**Figure 1: Switching Test Circuit**



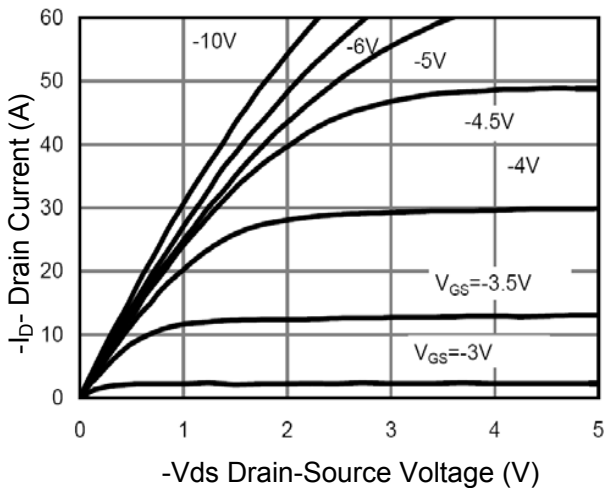
**Figure 2: Switching Waveforms**



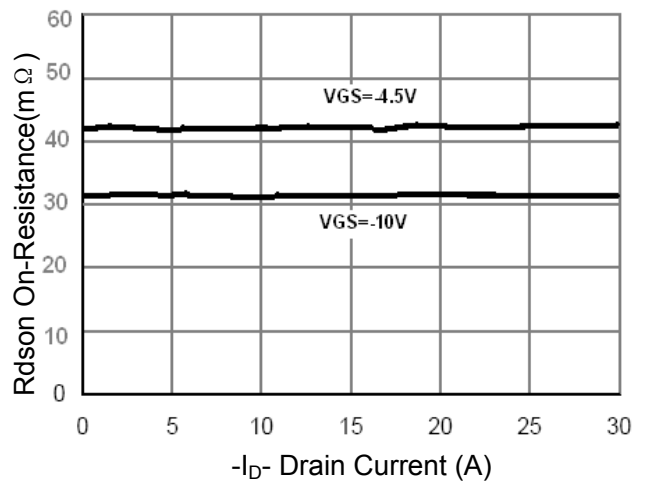
**Figure 3 Power Dissipation**



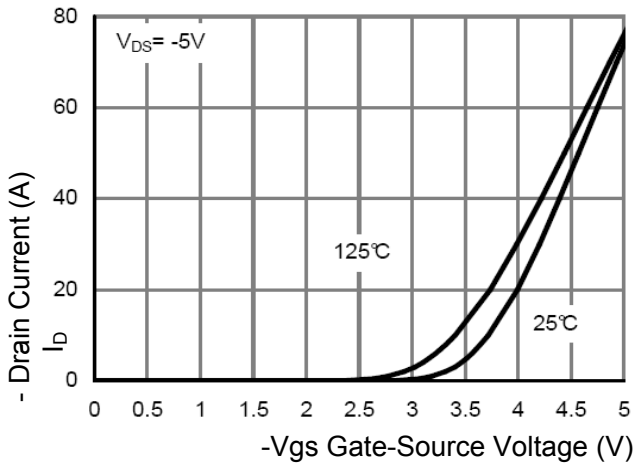
**Figure 4 Drain Current**



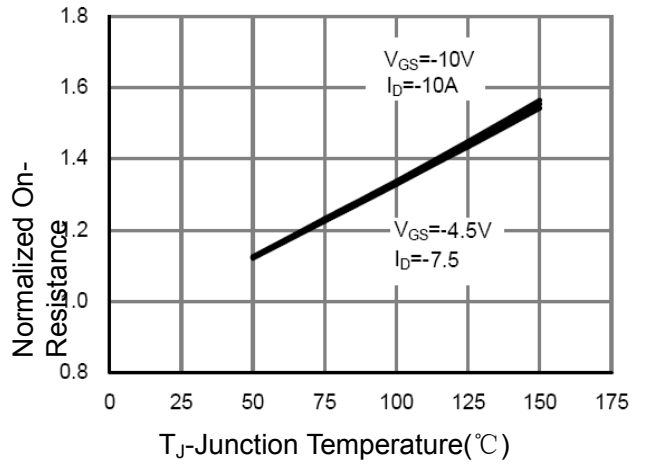
**Figure 5 Output CHARACTERISTICS**



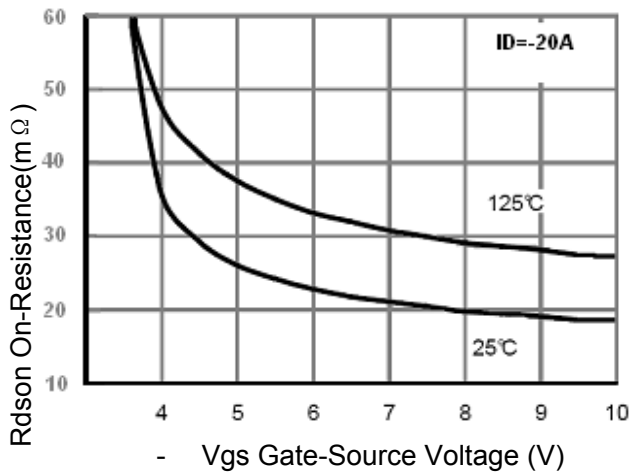
**Figure 6 Drain-Source On-Resistance**



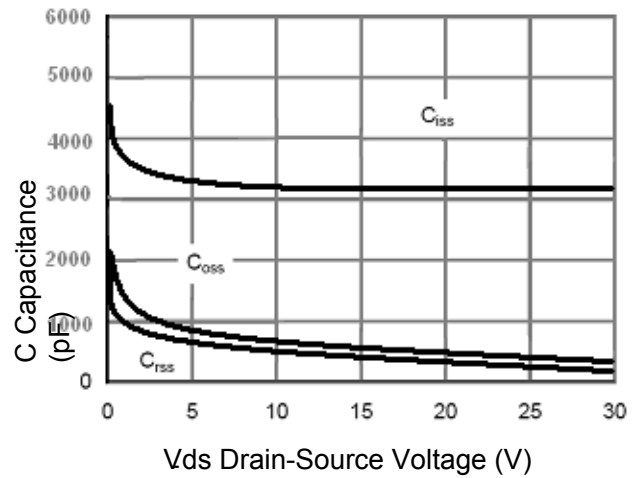
**Figure 7 Transfer Characteristics**



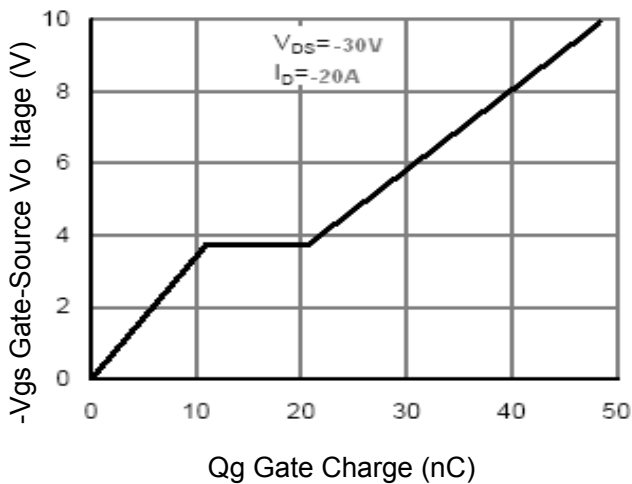
**Figure 8 Drain-Source On-Resistance**



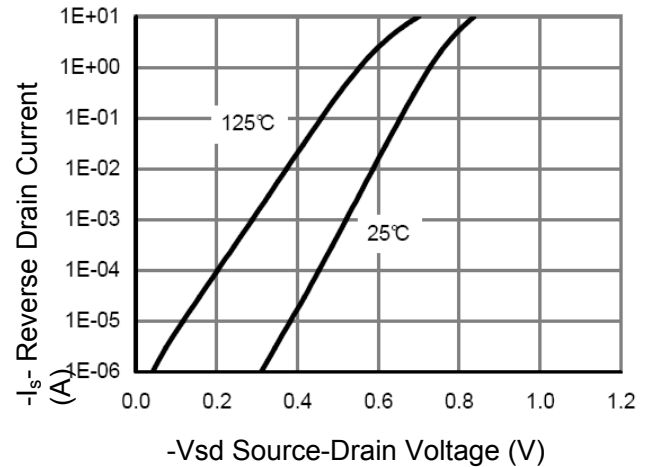
**Figure 9 Rdson vs Vgs**



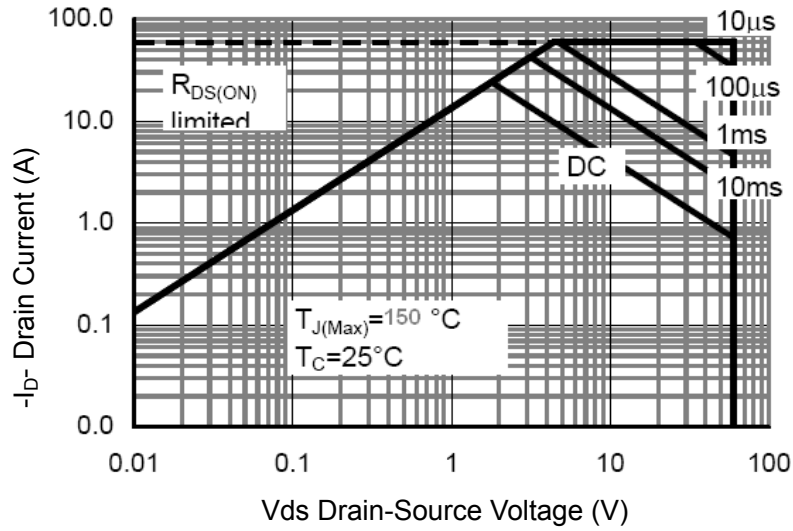
**Figure 10 Capacitance vs Vds**



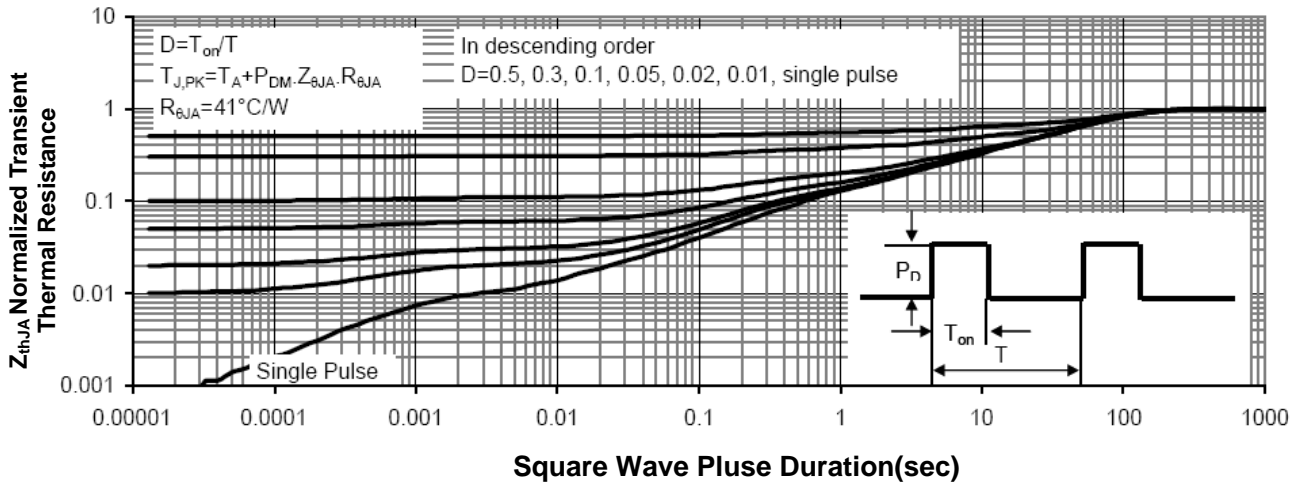
**Figure 11 Gate Charge**



**Figure 12 Source- Drain Diode Forward**

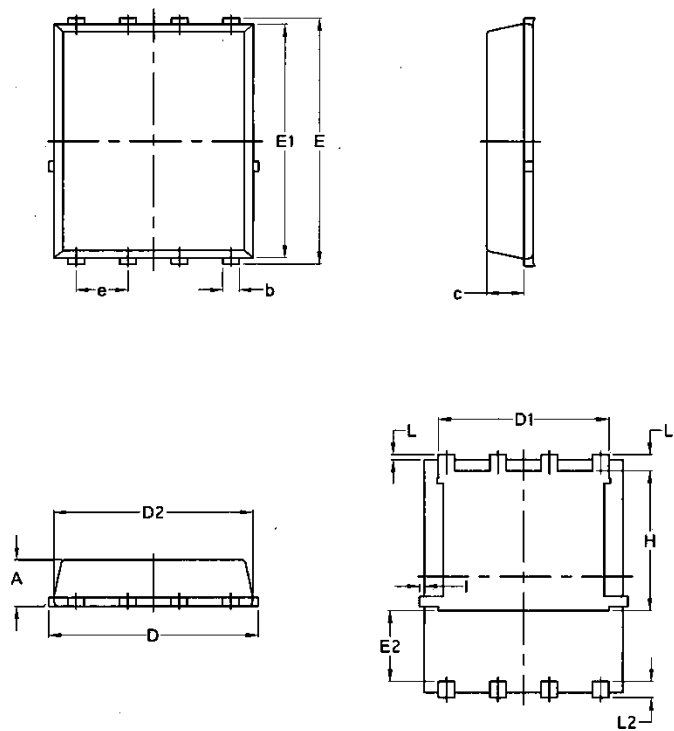


**Figure 13 Safe Operation Area**



**Figure 14 Normalized Maximum Transient Thermal Impedance**

**Package Mechanical Data-DFN5\*6-8L-JQ Single**



Symbol	Common			
	mm		Inch	
	Min	Max	Min	Max
A	1.03	1.17	0.0406	0.0461
b	0.34	0.48	0.0134	0.0189
c	0.824	0.0970	0.0324	0.082
D	4.80	5.40	0.1890	0.2126
D1	4.11	4.31	0.1618	0.1697
D2	4.80	5.00	0.1890	0.1969
E	5.95	6.15	0.2343	0.2421
E1	5.65	5.85	0.2224	0.2303
E2	1.60	/	0.0630	/
e	1.27 BSC		0.05 BSC	
L	0.05	0.25	0.0020	0.0098
L1	0.38	0.50	0.0150	0.0197
L2	0.38	0.50	0.0150	0.0197
H	3.30	3.50	0.1299	0.1378
I	/	0.18	/	0.0070