

General Description

The AO4466 uses advanced trench technology to provide excellent $R_{DS(ON)}$, low gate charge and operation with gate voltages as low as 4.5V. This device is suitable for use as a Battery protection or in other Switching application.



: YUhi fYg

V_{DS}	30	X
I_D	8	C
$T_{FUTOP}(V_{GS}=10V)$	19	o á
$T_{FUTOP}(V_{GS}=4.5V)$	24	o á

Application

- Battery protection
- 5V regulator
- Motor driver

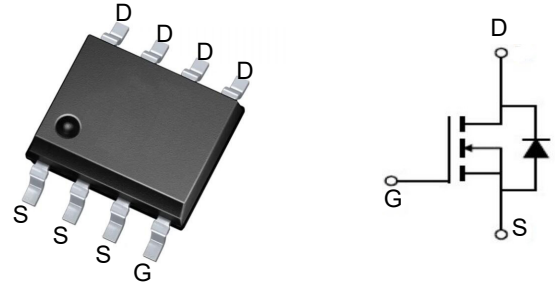

Pin Configuration

Part Number	Package	Part Number	Pin Configuration
AO4466	TO-18	AO4466	TO-18

5 Vgs`i hY`AU ja i a `FU]b[g`fH, 1&) °C unless otherwise noted)

Symbol	Parameter	Rating	Units
V_{DS}	Drain-Source Voltage	30	V
V_{GS}	Gate-Source Voltage	± 20	V
$I_D@T_A=25^\circ C$	Continuous Drain Current, $V_{GS} @ 10V^1$	8	A
$I_D@T_A=70^\circ C$	Continuous Drain Current, $V_{GS} @ 10V^1$	5.8	A
I_{DM}	Pulsed Drain Current ²	30	A
EAS	Single Pulse Avalanche Energy ³	20	mJ
I_{AS}	Avalanche Current	22	A
$P_D@T_A=25^\circ C$	Total Power Dissipation ⁴	4.5	W
T_{STG}	Storage Temperature Range	-55 to 150	°C
T_J	Operating Junction Temperature Range	-55 to 150	°C
$R_{\theta JA}$	Thermal Resistance Junction-ambient ¹	50	°C/W
$R_{\theta JC}$	Thermal Resistance Junction-Case ¹	30	°C/W

Electrical Characteristics (T_J=25 °C, unless otherwise noted)

Symbol	Parameter	Conditions	Min.	Typ.	Max.	Unit
BV _{DSS}	Drain-Source Breakdown Voltage	V _{GS} =0V, I _D =250uA	30	33	---	V
ΔBV _{DSS} /ΔT _J	BVDSS Temperature Coefficient	Reference to 25 °C, I _D =1mA	---	0.027	---	V/°C
R _{DS(ON)}	Static Drain-Source On-Resistance ²	V _{GS} =10V, I _D =10A	---	19	28	mΩ
		V _{GS} =4.5V, I _D =8A	---	24	40	
V _{GS(th)}	Gate Threshold Voltage		1.0	1.5	2.4	V
ΔV _{GS(th)}	V _{GS(th)} Temperature Coefficient	V _{GS} =V _{DS} , I _D =250uA	---	-5.8	---	mV/°C
I _{DSS}	Drain-Source Leakage Current	V _{DS} =24V, V _{GS} =0V, T _J =25 °C	---	---	1	uA
		V _{DS} =24V, V _{GS} =0V, T _J =55 °C	---	---	10	
I _{GSS}	Gate-Source Leakage Current	V _{GS} =±20V, V _{DS} =0V	---	---	±100	nA
g _{fs}	Forward Transconductance	V _{DS} =5V, I _D =10A	---	5.8	---	S
R _g	Gate Resistance	V _{DS} =0V, V _{GS} =0V, f=1MHz	---	2.2	3.8	
Q _g	Total Gate Charge (4.5V)	V _{DS} =15V, V _{GS} =4.5V, I _D =10A	---	12.6	17.6	nC
Q _{gs}	Gate-Source Charge		---	4.2	5.9	
Q _{gd}	Gate-Drain Charge		---	5.1	7.1	
T _{d(on)}	Turn-On Delay Time	V _{DD} =15V, V _{GS} =10V, R _G =3.3 I _D =10A	---	6.2	12.4	ns
T _r	Rise Time		---	59	106	
T _{d(off)}	Turn-Off Delay Time		---	27.6	55	
T _f	Fall Time		---	8.4	16.8	
C _{iss}	Input Capacitance	V _{DS} =15V, V _{GS} =0V, f=1MHz	---	960	---	pF
C _{oss}	Output Capacitance		---	139	---	
C _{rss}	Reverse Transfer Capacitance		---	87	---	
I _S	Continuous Source Current ^{1,5}	V _G =V _D =0V, Force Current	---	---	10.3	A
I _{SM}	Pulsed Source Current ^{2,5}		---	---	42	A
V _{SD}	Diode Forward Voltage ²	V _{GS} =0V, I _S =1A, T _J =25 °C	---	---	1.2	V
t _{rr}	Reverse Recovery Time	I _F =10A, di/dt=100A/μs, T _J =25 °C	---	12.5	---	nS
Q _{rr}	Reverse Recovery Charge		---	5	---	nC

Note :

- The data tested by surface mounted on a 1 inch² FR-4 board with 20Z copper.
- The data tested by pulsed, pulse width ≤ 300us, duty cycle ≤ 2%
- The EAS data shows Max. rating. The test condition is V_{DD}=25V, V_{GS}=10V, L=0.1mH, I_{AS}=35A
- The power dissipation is limited by 150°C junction temperature
- The data is theoretically the same as I_D and I_{DM}, in real applications, should be limited by total power dissipation.

Typical Characteristics

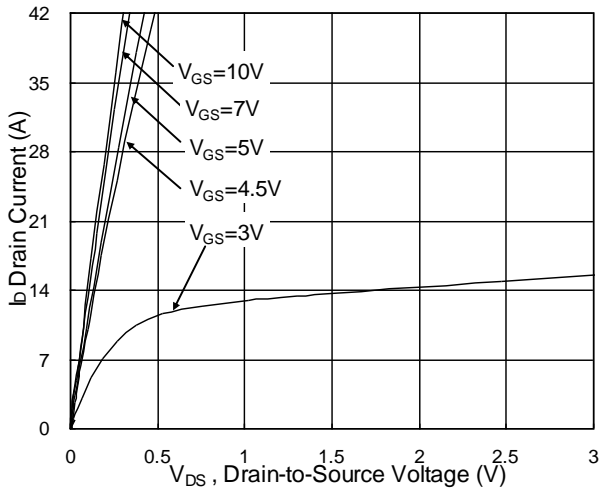

Fig.1 Typical Output Characteristics

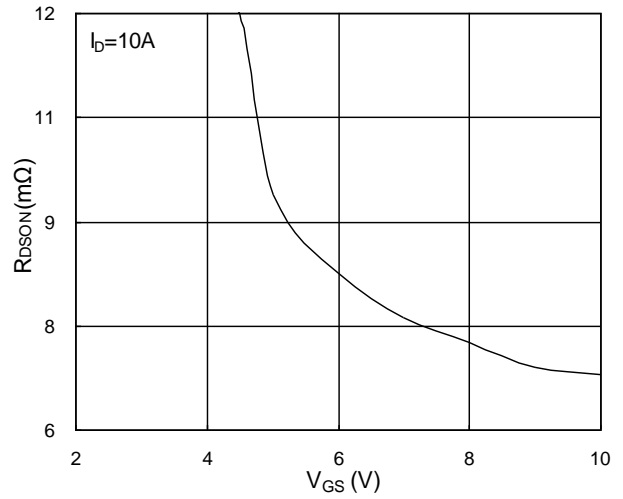

Fig.2 On-Resistance vs. Gate-Source

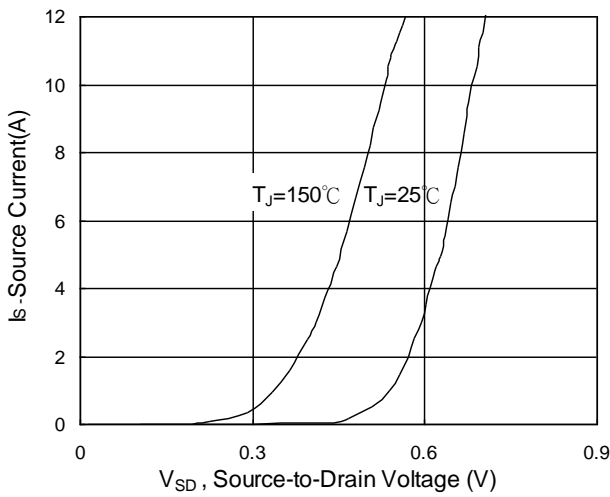

Fig.3 Forward Characteristics of reverse

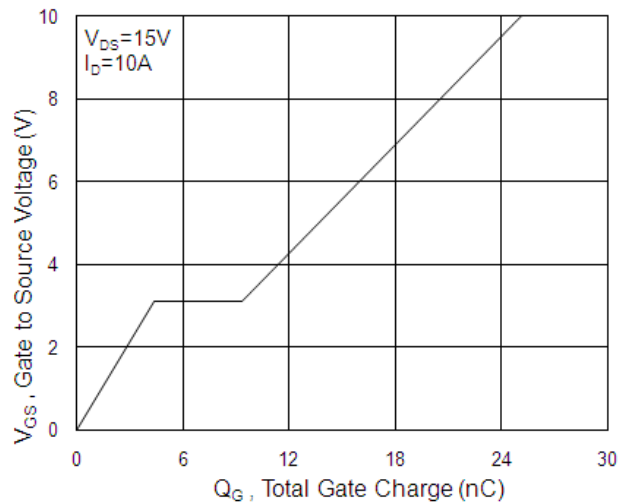

Fig.4 Gate-Charge Characteristics

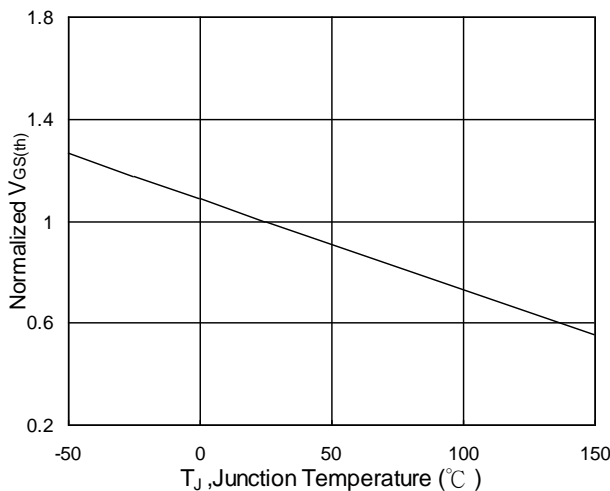

Fig.5 Normalized $V_{GS(th)}$ vs. T_J

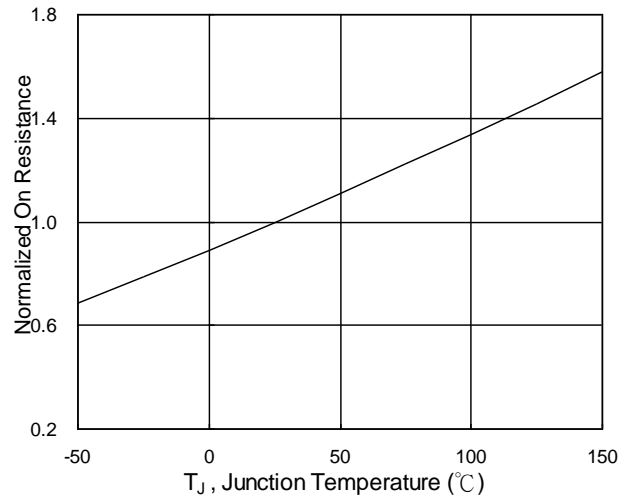

Fig.6 Normalized $R_{DS(on)}$ vs. T_J

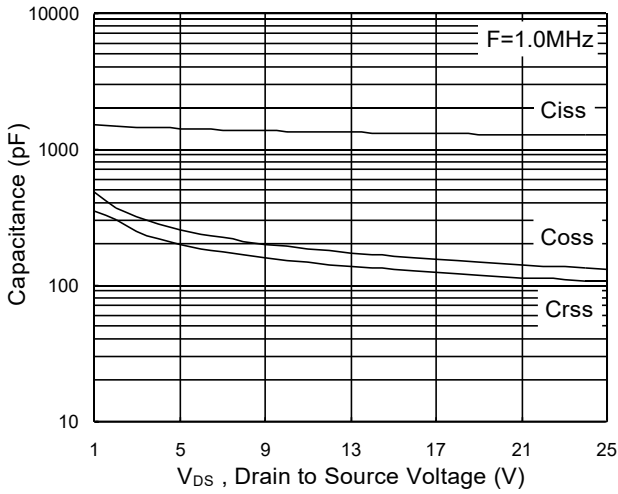

Fig.7 Capacitance

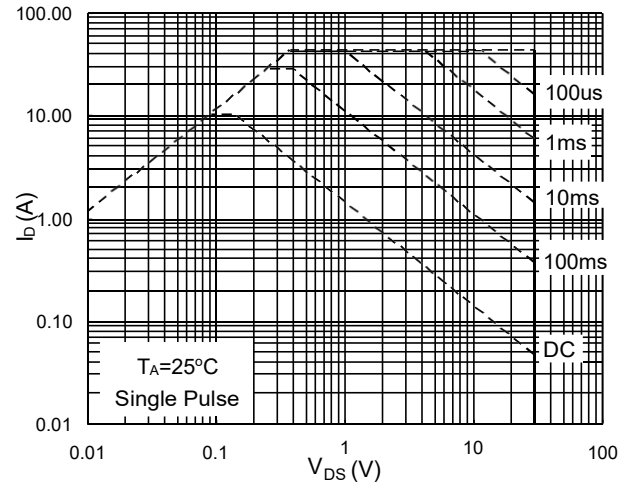

Fig.8 Safe Operating Area

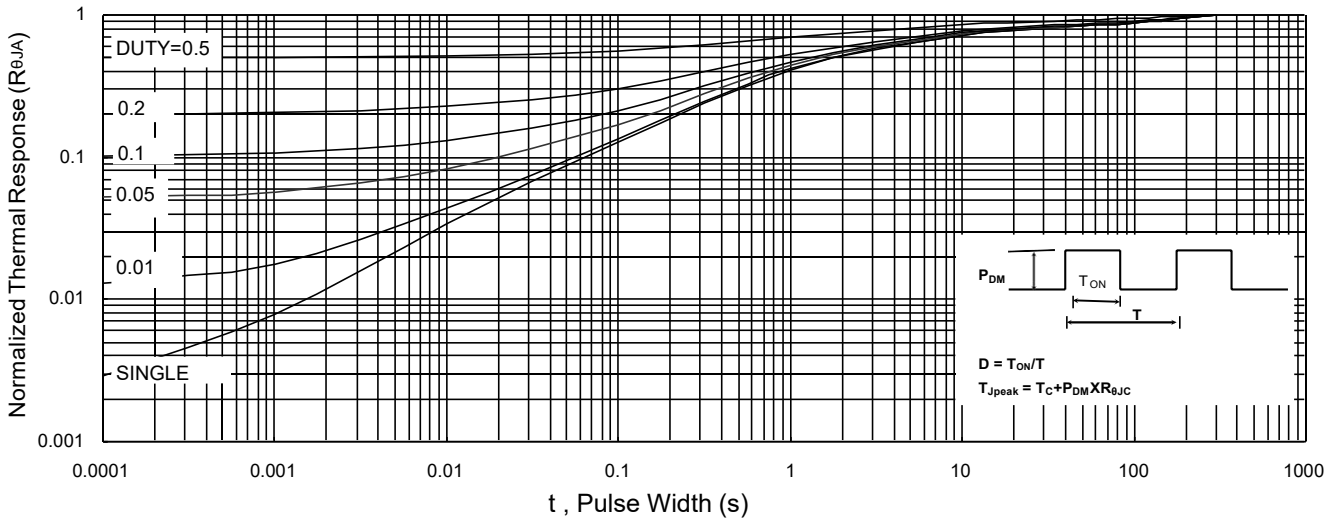

Fig.9 Normalized Maximum Transient Thermal Impedance

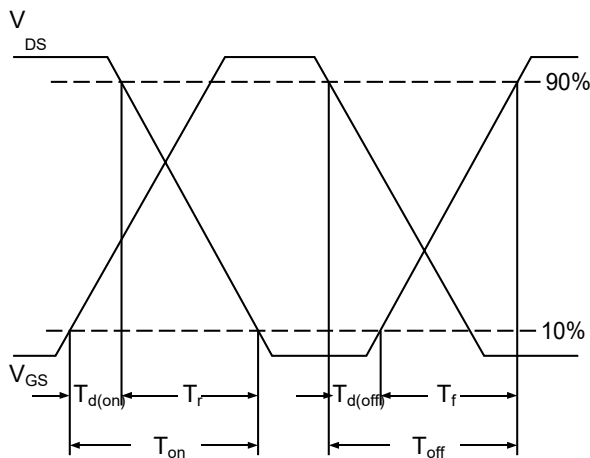

Fig.10 Switching Time Waveform

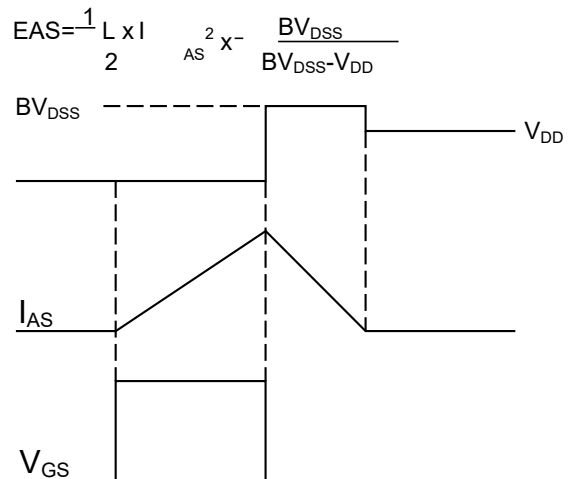
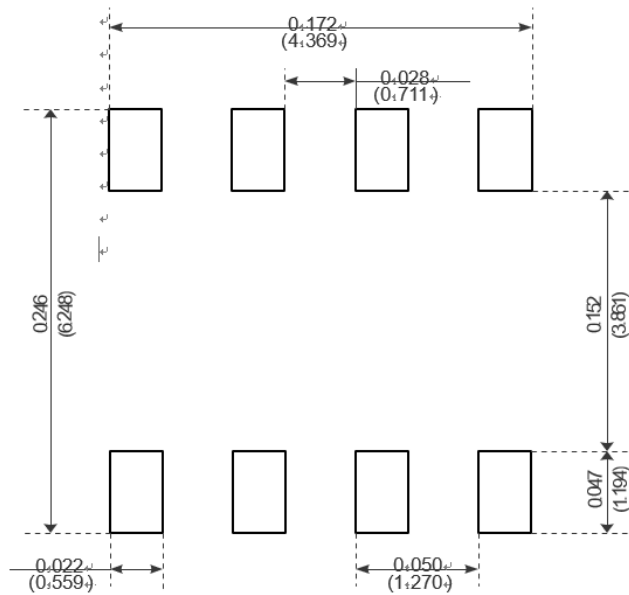
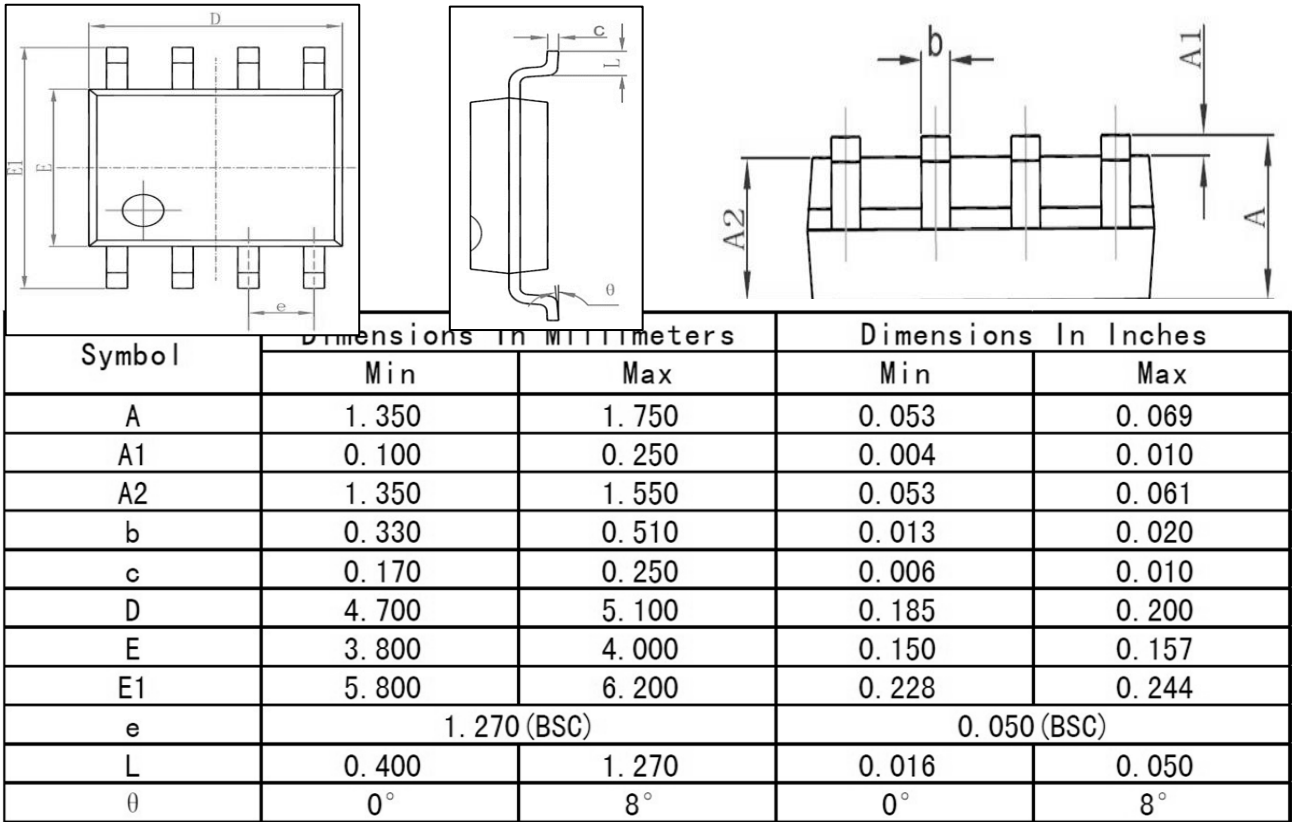

Fig.11 Unclamped Inductive Switching Waveform

Package Mechanical Data-SOP-8



Recommended Minimum Pads